

Opel Meriva (2010-)

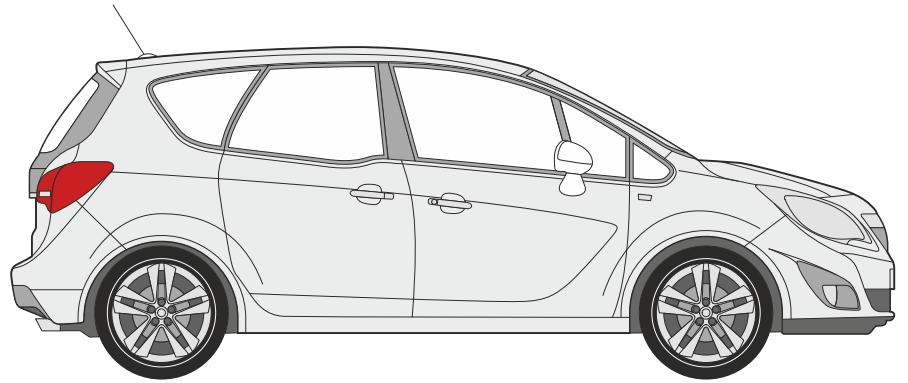

94/20/EC

Opel Meriva (2010-)

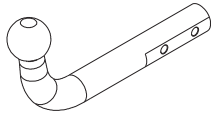

e13	APPROVALNUMBER	D-VALUE
	00-3306	D 9,08 kN
	TYPE	CLASS
	OPL037	A50-X
	MAX.VERT.LOAD	
	S 85 kg	

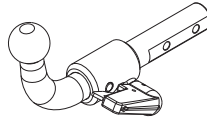

e13	APPROVALNUMBER	D-VALUE
	00-3307	D 9,08 kN
	TYPE	CLASS
	OPL038-S	A50-X
	MAX.VERT.LOAD	
	S 85 kg	

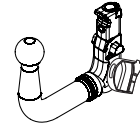

e13	APPROVALNUMBER	D-VALUE
	00-3307	D 9,08 kN
	TYPE	CLASS
	OPL038-V	A50-X
	MAX.VERT.LOAD	
	S 85 kg	

D= 9,08 kN



T= 1500 Kg



S= 85 kg

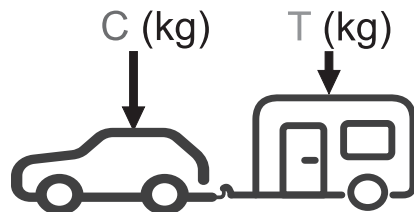
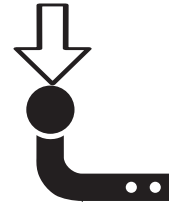

$g = 9,81 \text{ m/s}^2$

$$D \geq \frac{T \cdot C}{T+C} \cdot \frac{g}{1000} \text{ (kN)}$$





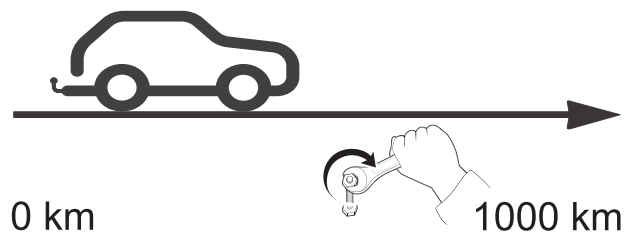

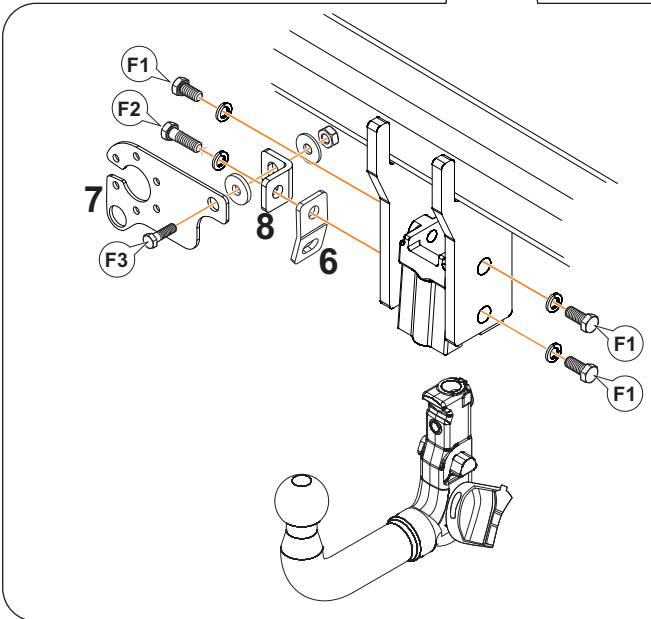
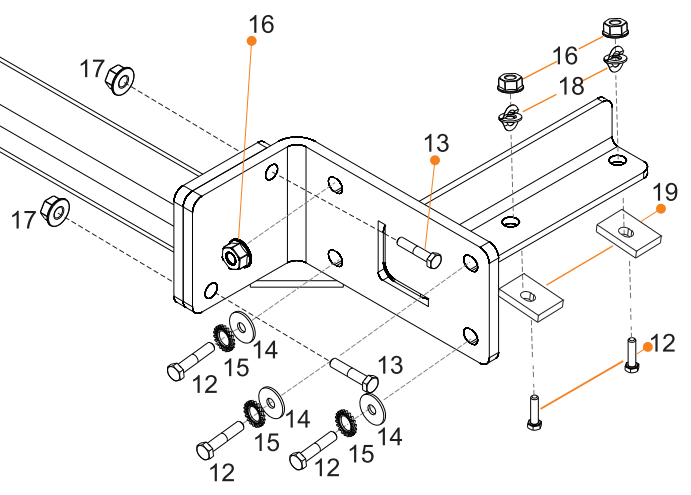
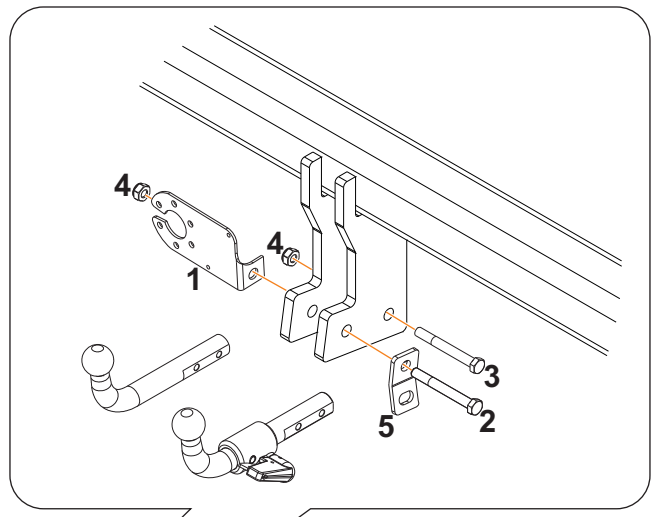
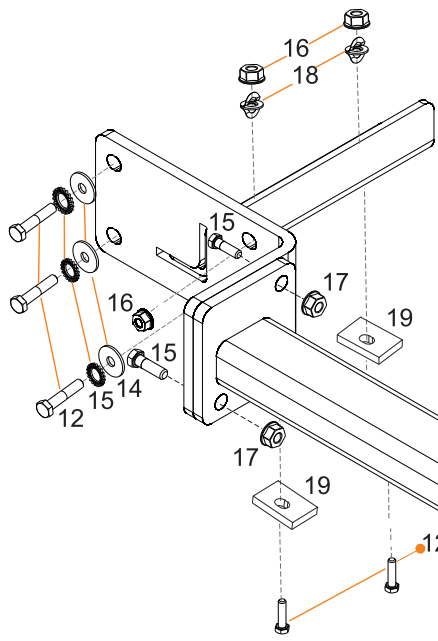



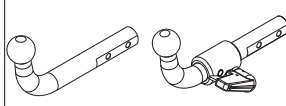
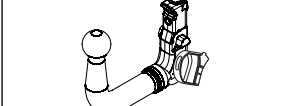









$$T \leq \frac{C \cdot D \cdot 1000}{(C \cdot g) - (1000 \cdot D)} \text{ (kg)}$$

	M8	M10	M12	M14
N/m	20	40	60	105
	M16			
				160





		#
F1	M12 x 25 DIN 933	3
	Ø12 Grower DIN 128	3
F2	M12 x 35 DIN 933	3
	Ø12 Grower DIN 128	1
F3	M10 x 30 DIN 933	1
	Ø10 Poliuretano / Nylon	1
	Ø10 DIN 9021	1
	M10 DIN 980	1

				
1		AEV0005	1	
2		M10x70 DIN 931	1	
3		M10x65 DIN 931	1	
4		M10 DIN 980	2	
5		AEV0004	1	1
6		AEV0006	1	1
7		AEV0009		1
8		AEV0008		1
9		C4515B	1	1
10		C4515BA21	1	1
11		C4515BA22	1	1
12		M10x40 DIN 933	10	10
13		M12x40 DIN 933	4	4
14		Ø10 DIN 9021	6	6
15		Ø10 DIN 6798	6	6
16		M10 DIN 6923	6	6
17		M12 DIN 6923	4	4
18			6	6
19		100x50x4	4	4

1

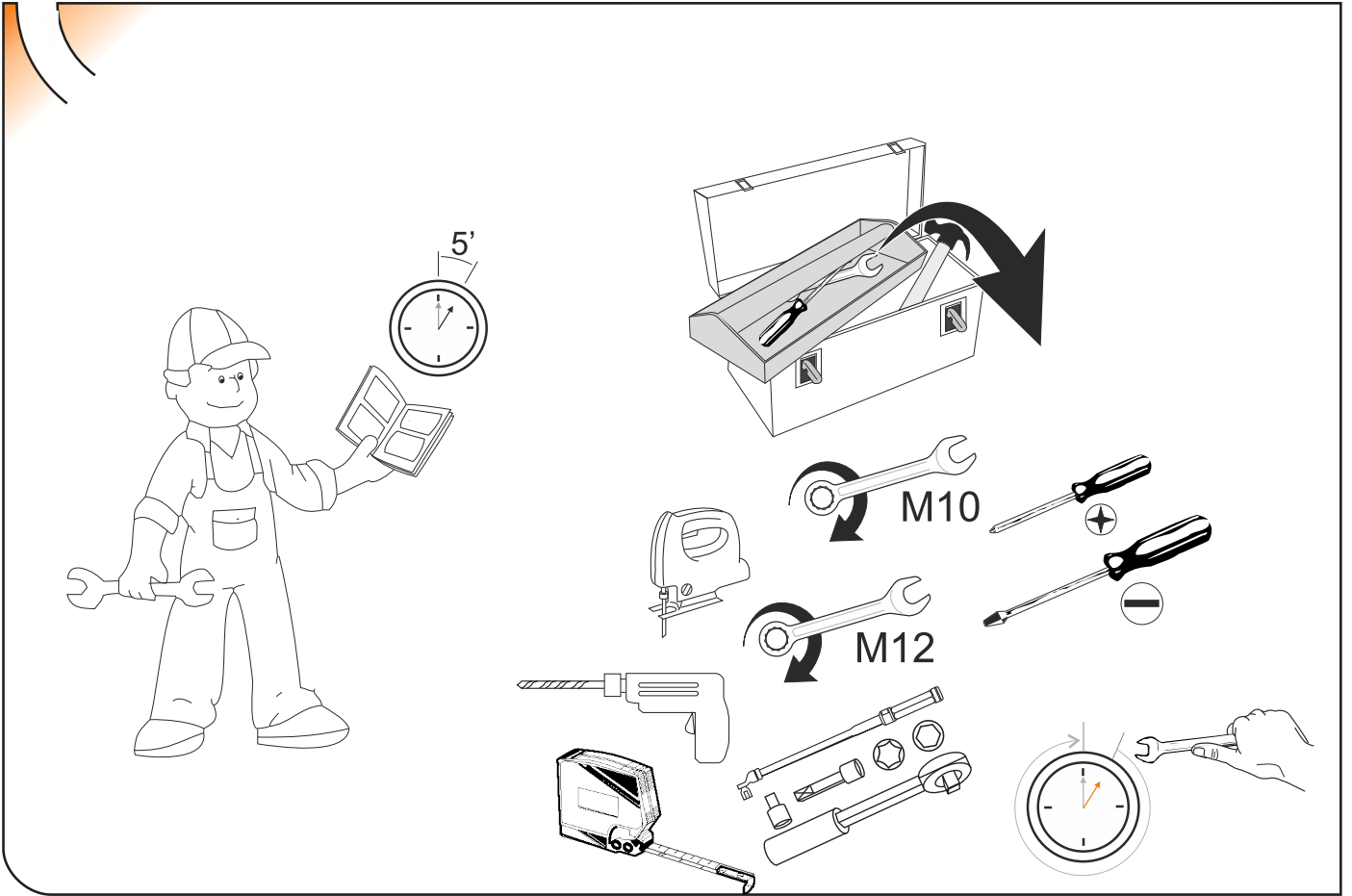

2

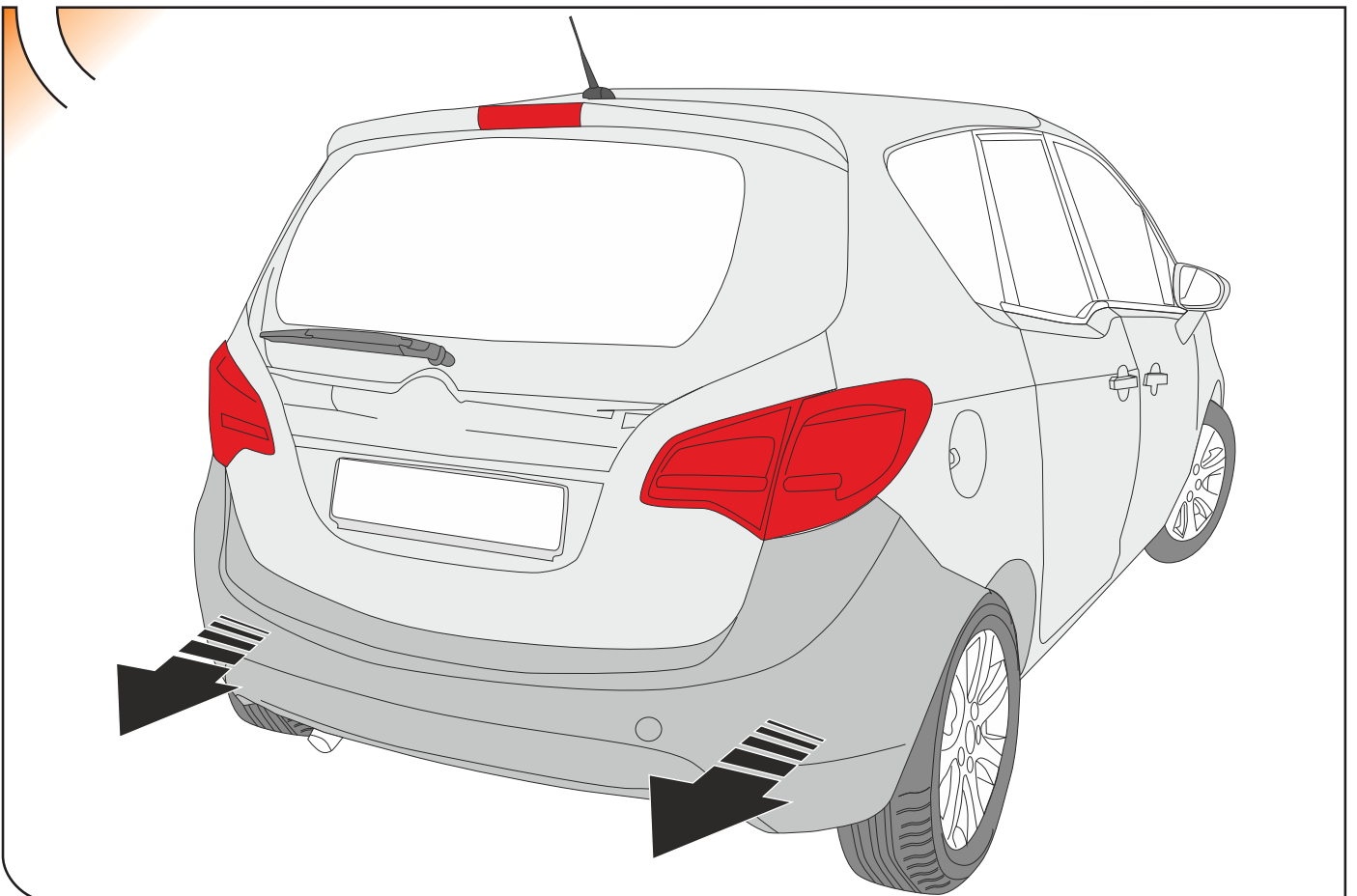

3

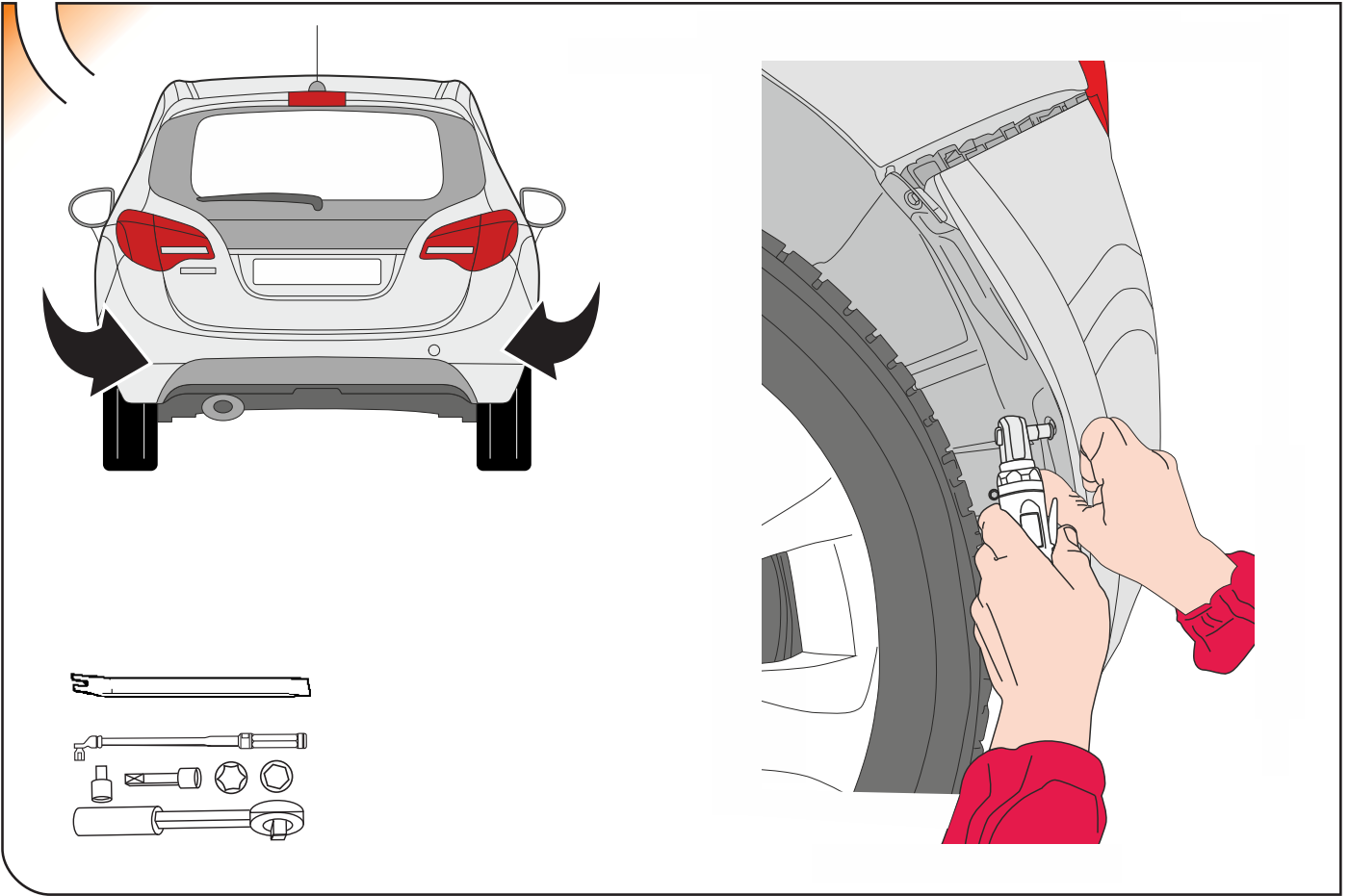

4

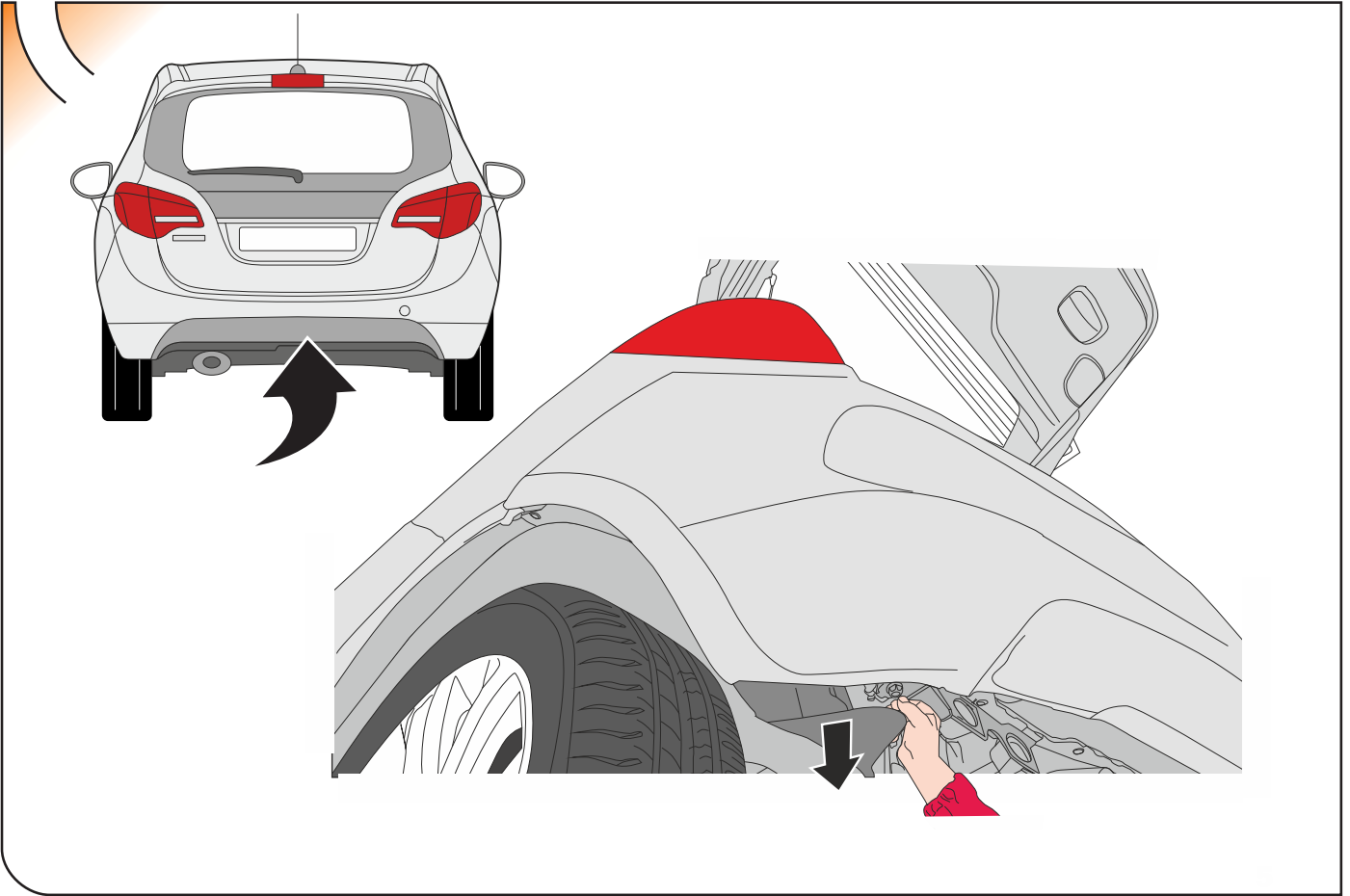

5

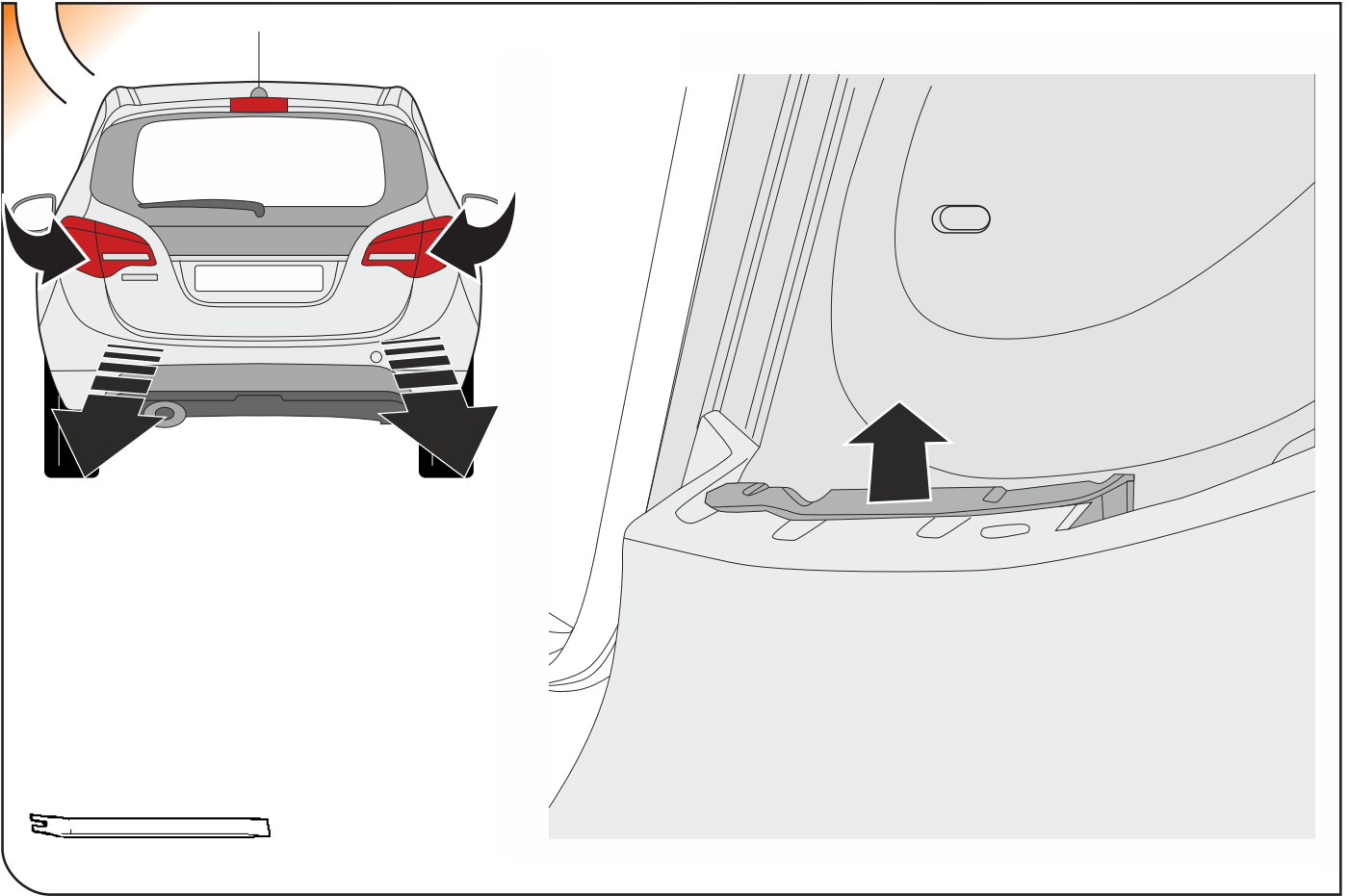

6

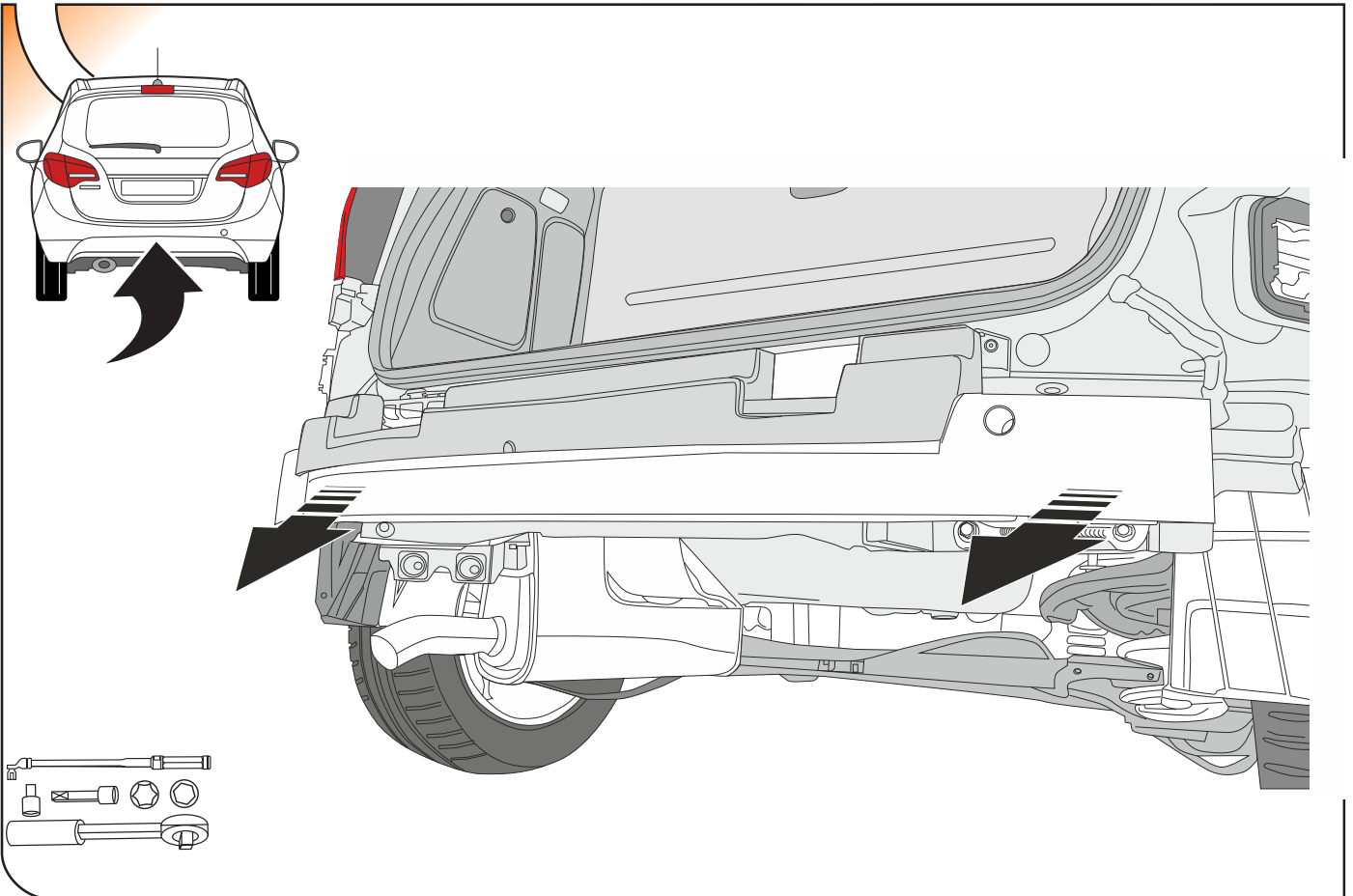

7

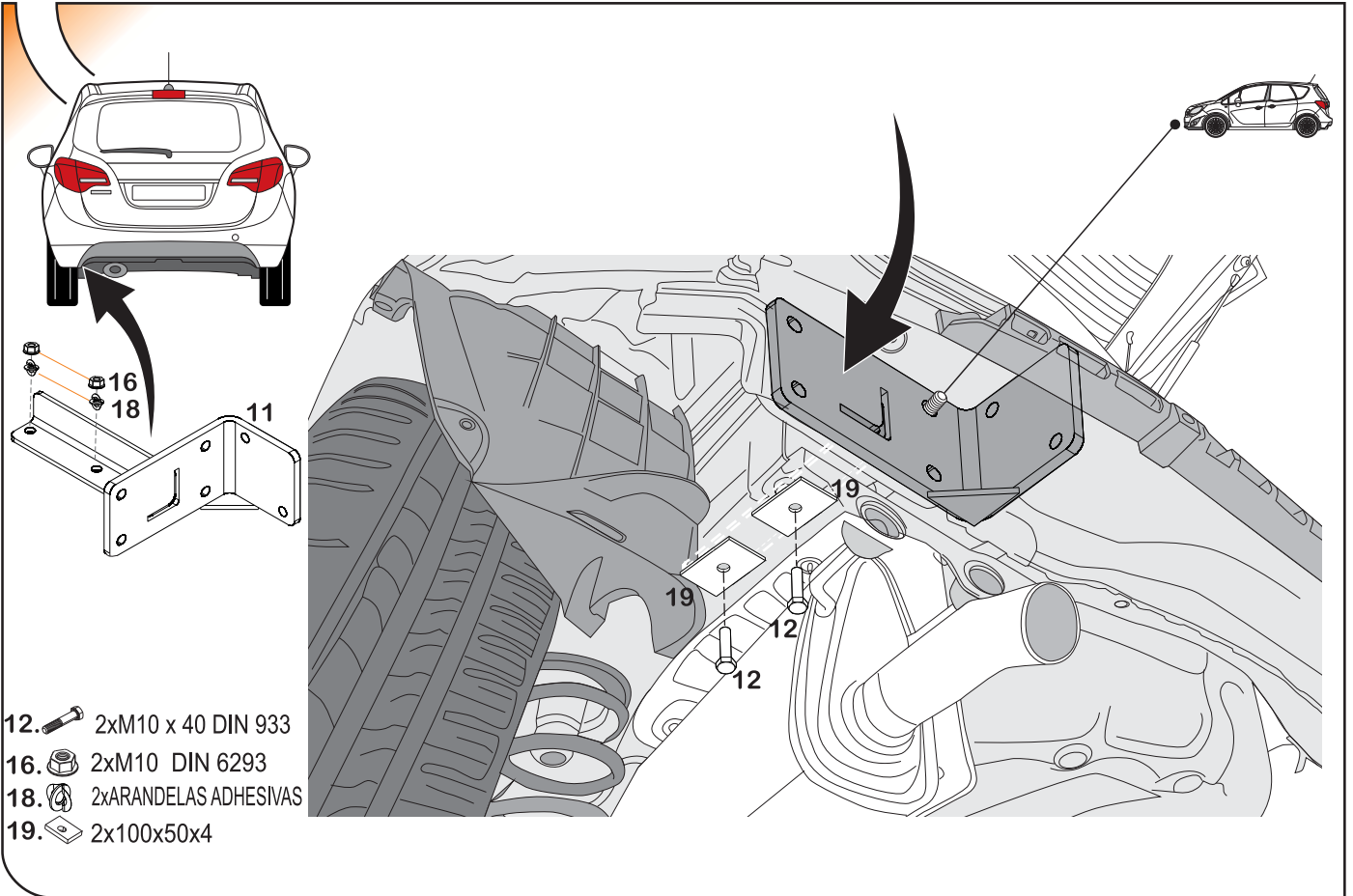

- 12. 2xM10 x 40 DIN 933
- 16. 2xM10 DIN 6293
- 18. 2xARANDELAS ADHESIVAS
- 19. 2x100x50x4



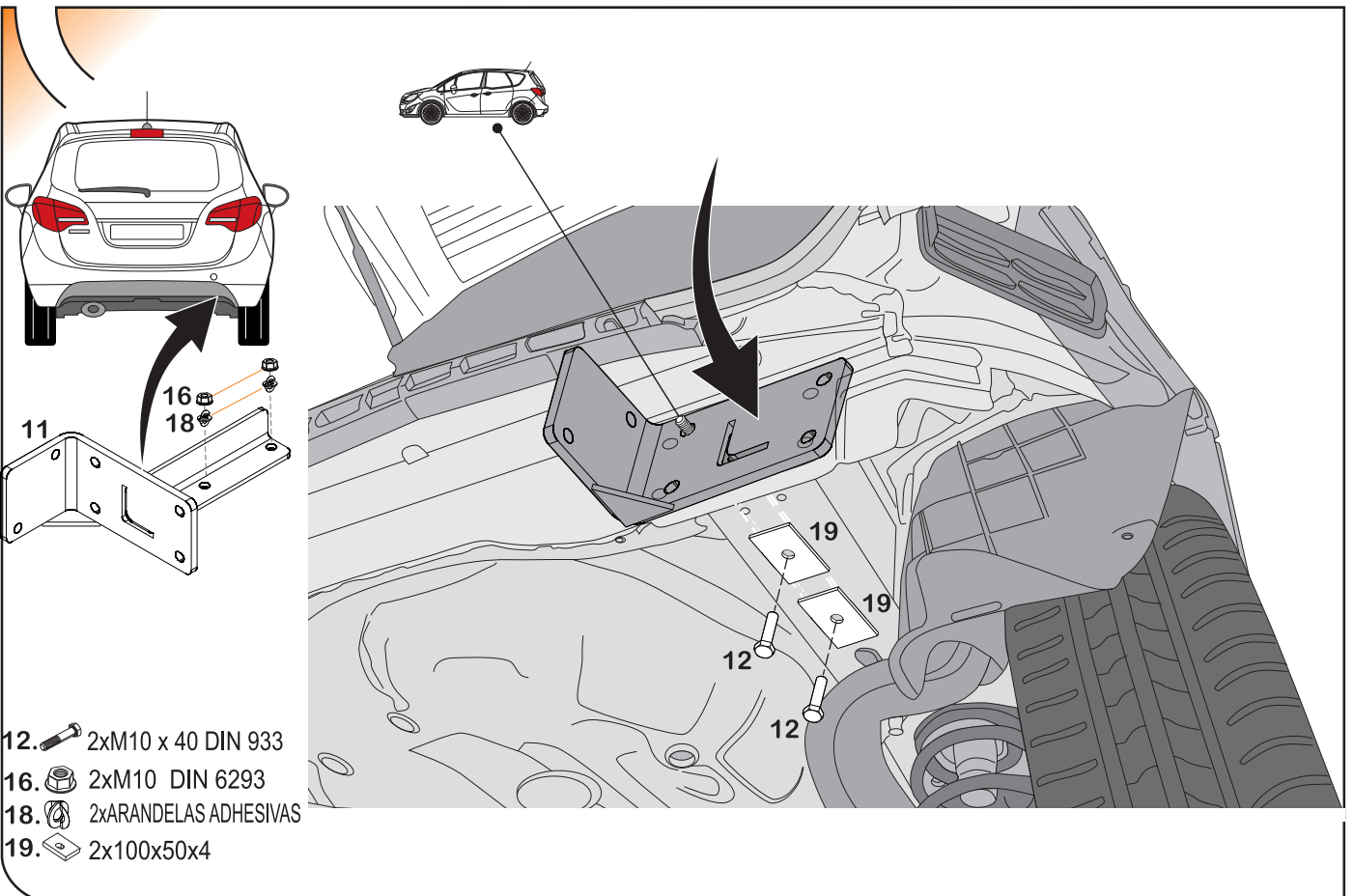



8

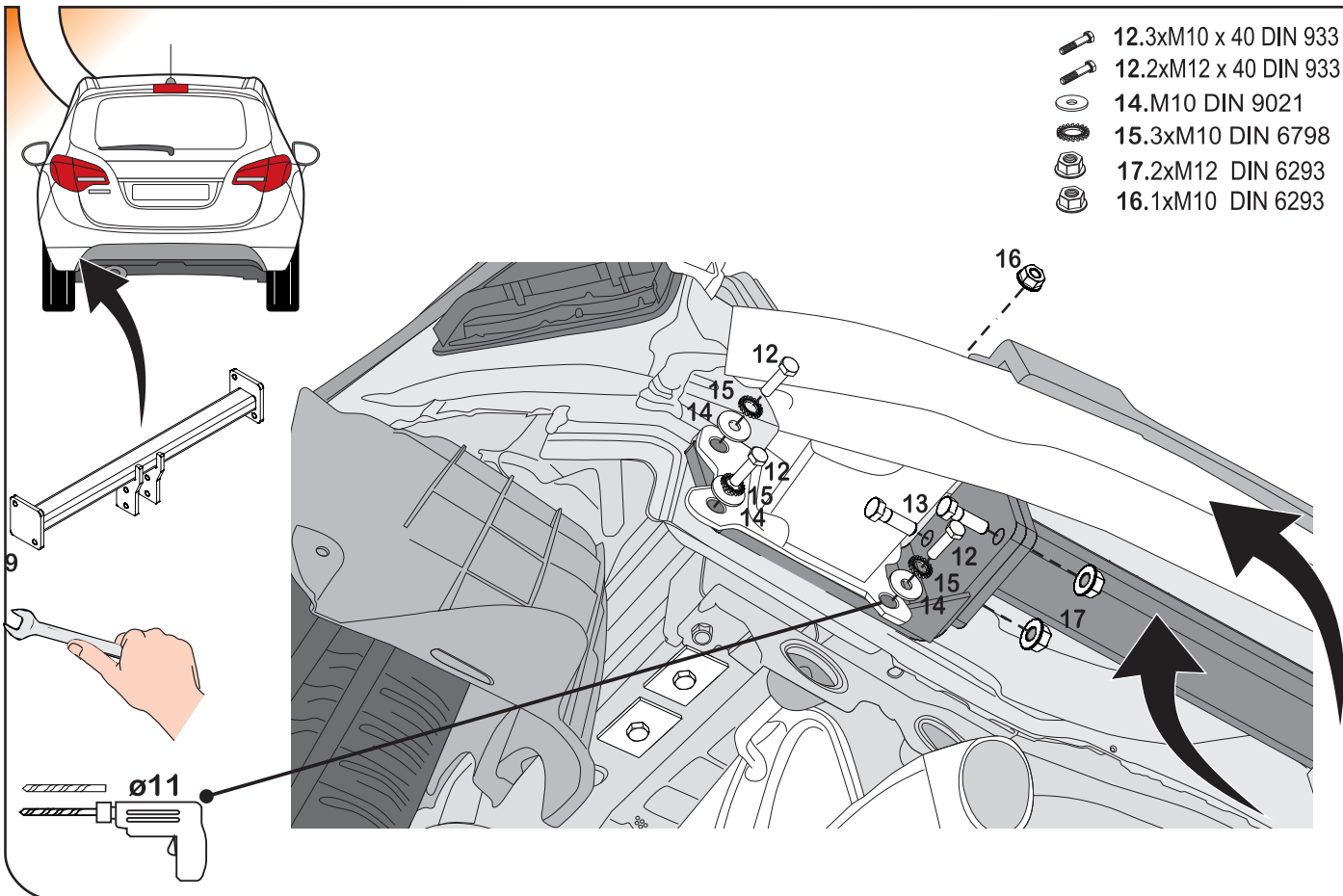

- 12. 2xM10 x 40 DIN 933
- 16. 2xM10 DIN 6293
- 18. 2xARANDELAS ADHESIVAS
- 19. 2x100x50x4







9

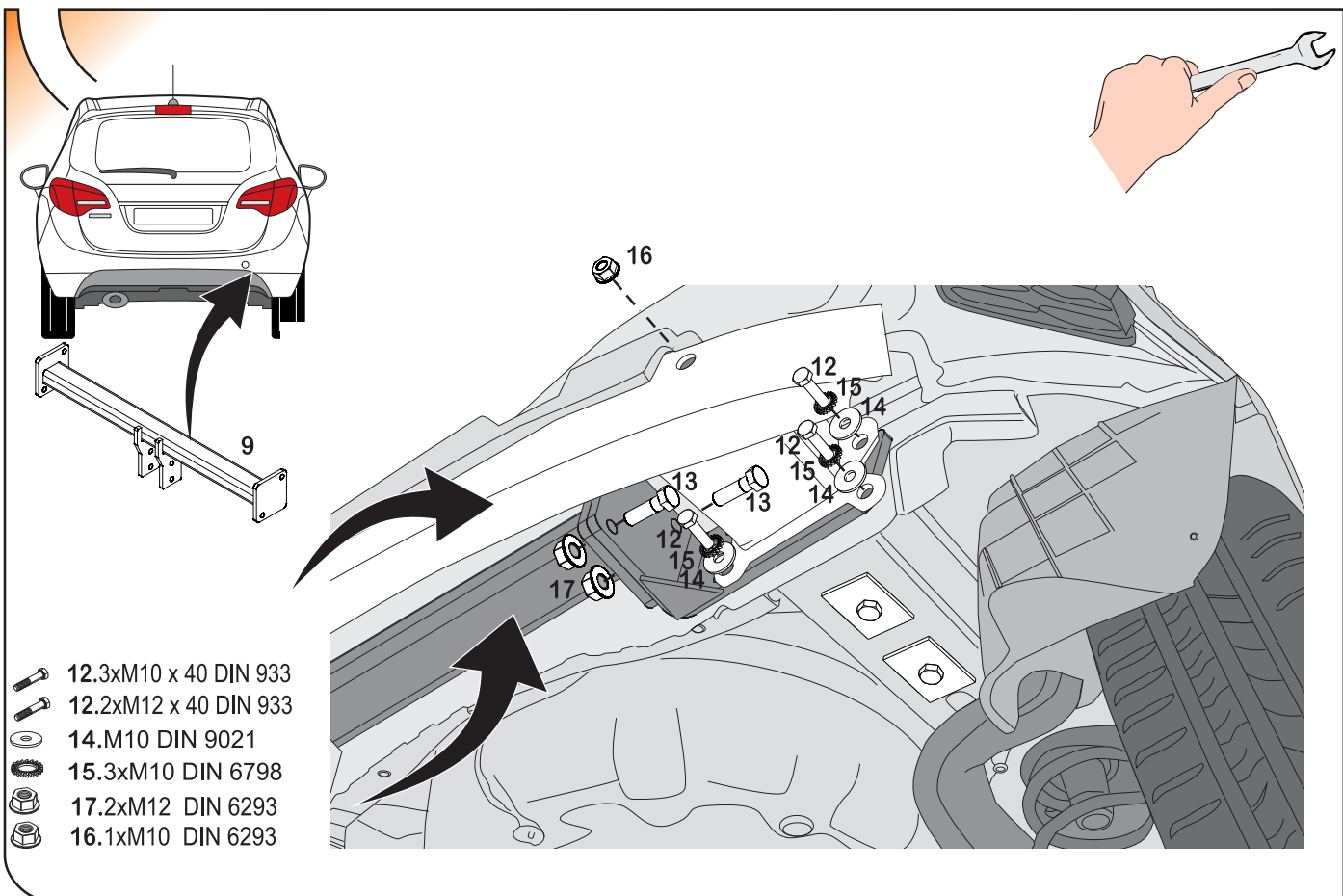

-  12.3xM10 x 40 DIN 933
-  12.2xM12 x 40 DIN 933
-  14.M10 DIN 9021
-  15.3xM10 DIN 6798
-  17.2xM12 DIN 6293
-  16.1xM10 DIN 6293

10



-  12.3xM10 x 40 DIN 933
-  12.2xM12 x 40 DIN 933
-  14.M10 DIN 9021
-  15.3xM10 DIN 6798
-  17.2xM12 DIN 6293
-  16.1xM10 DIN 6293

11

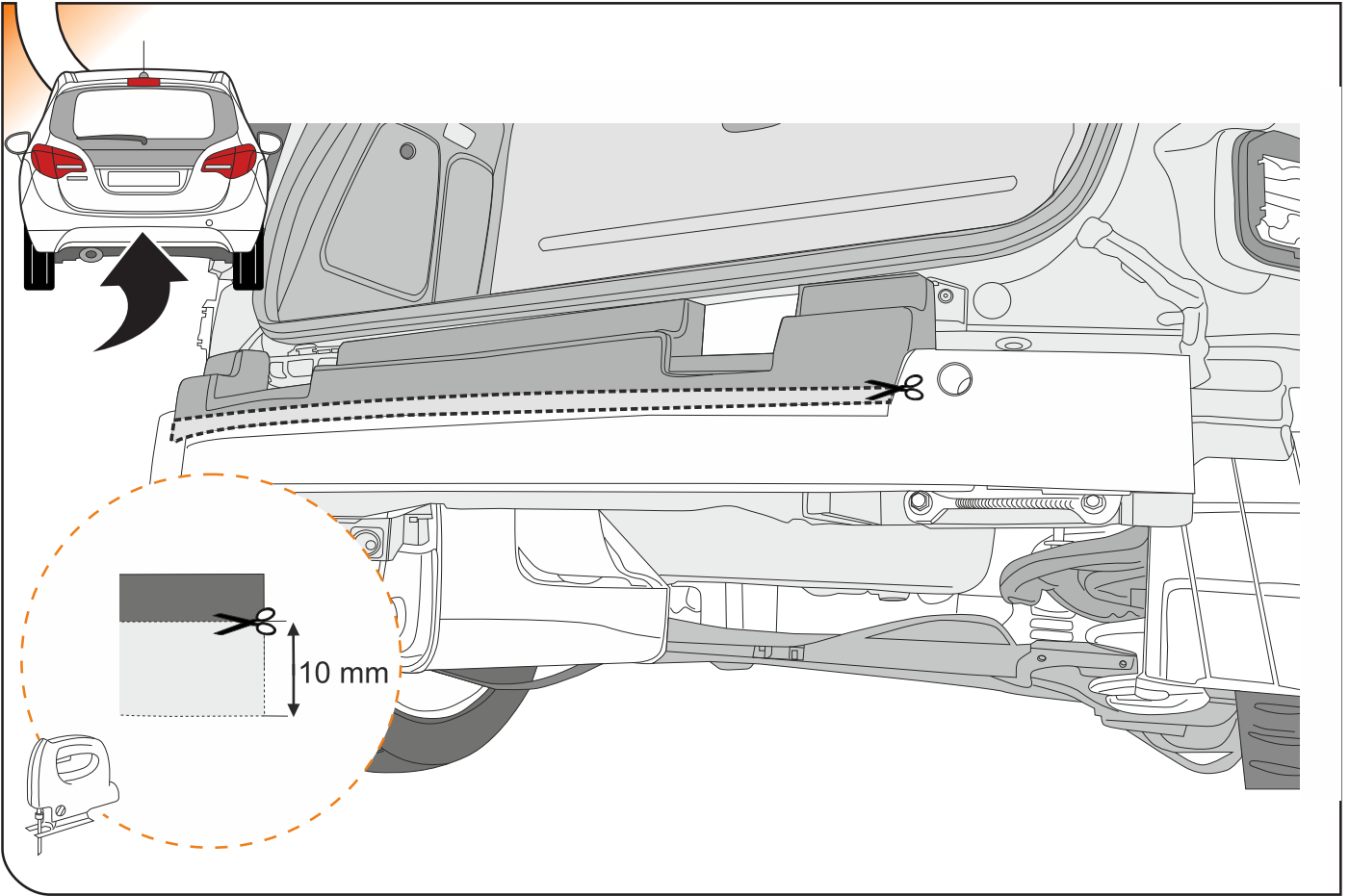

12

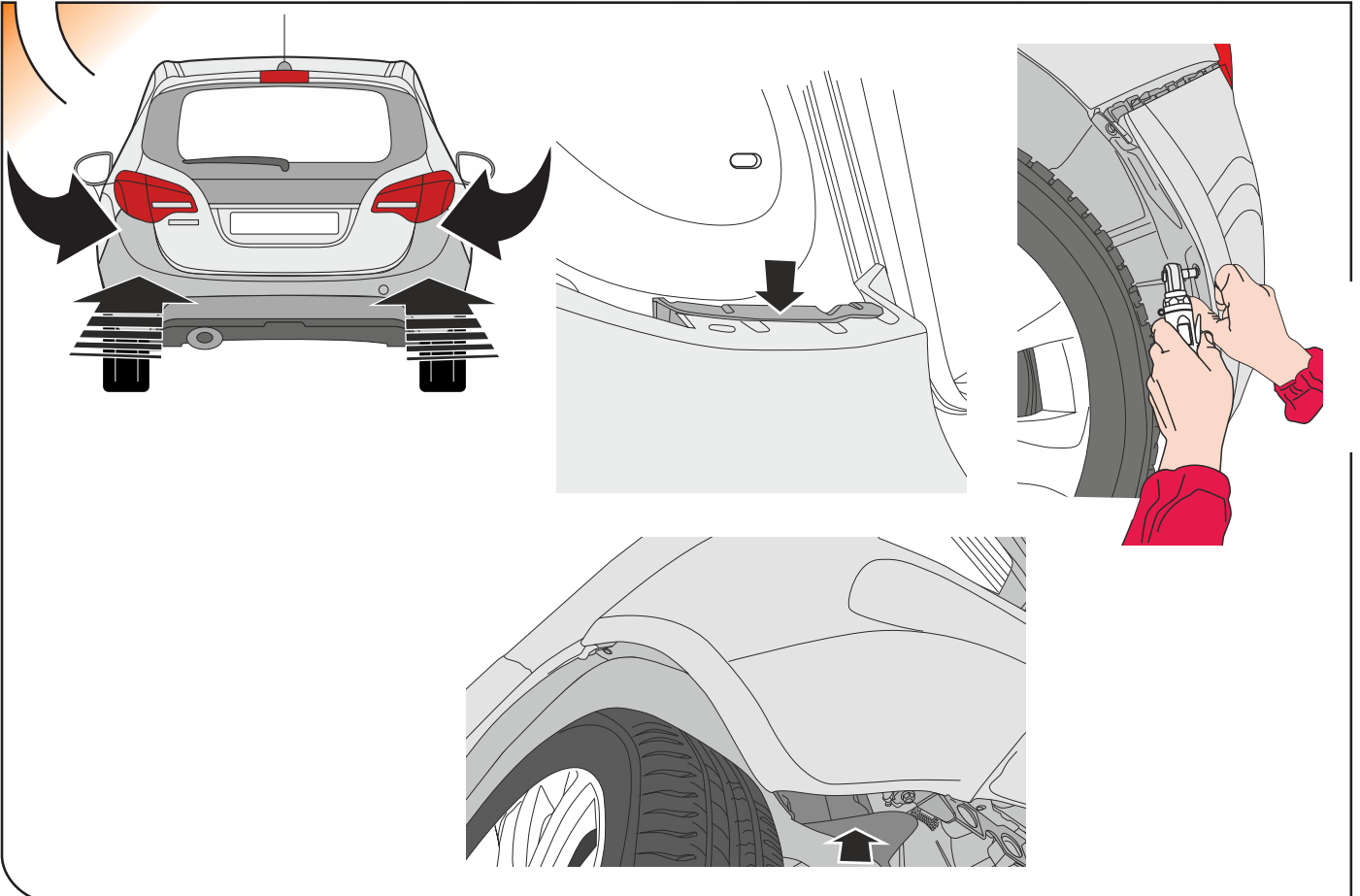

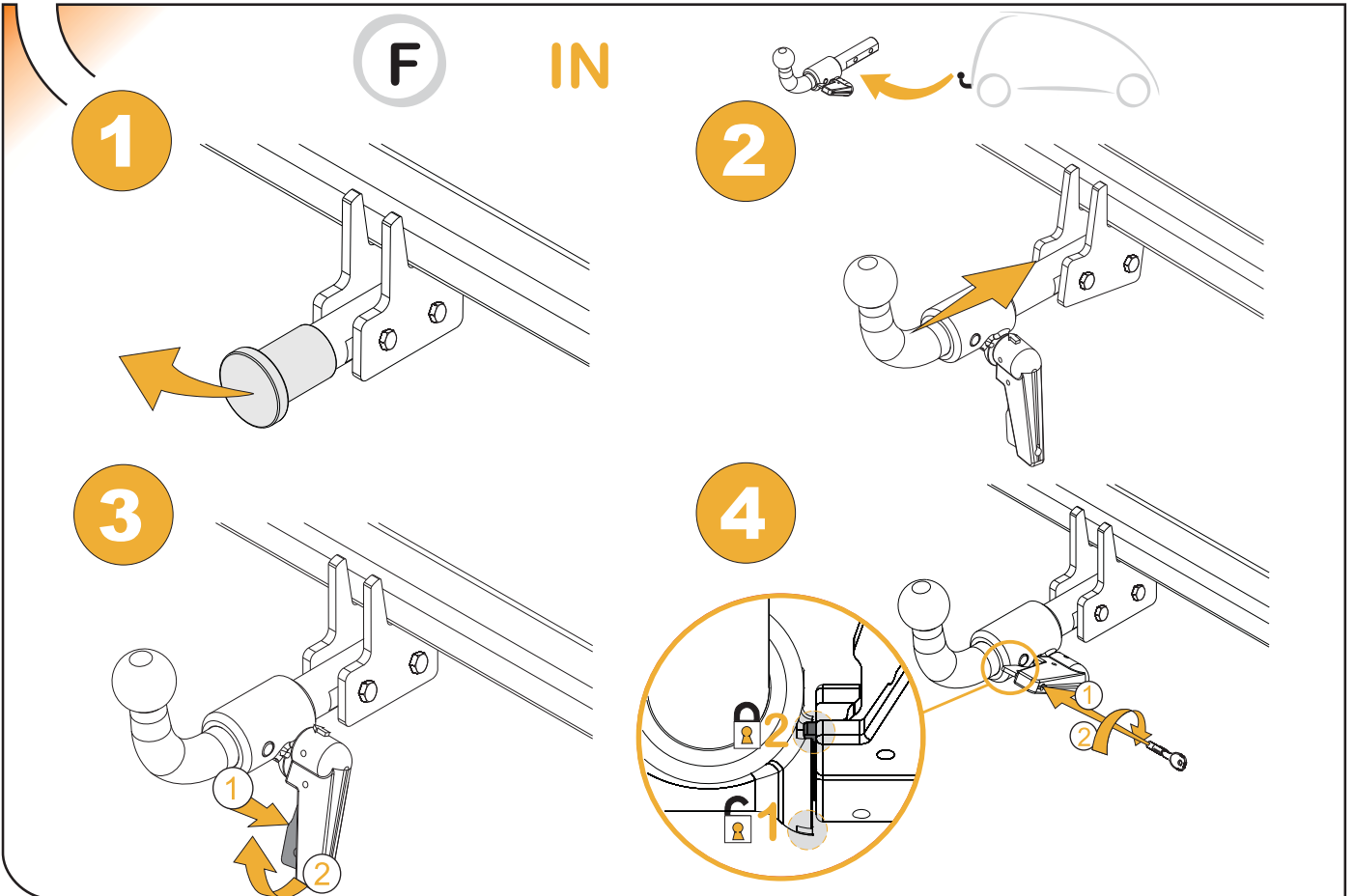
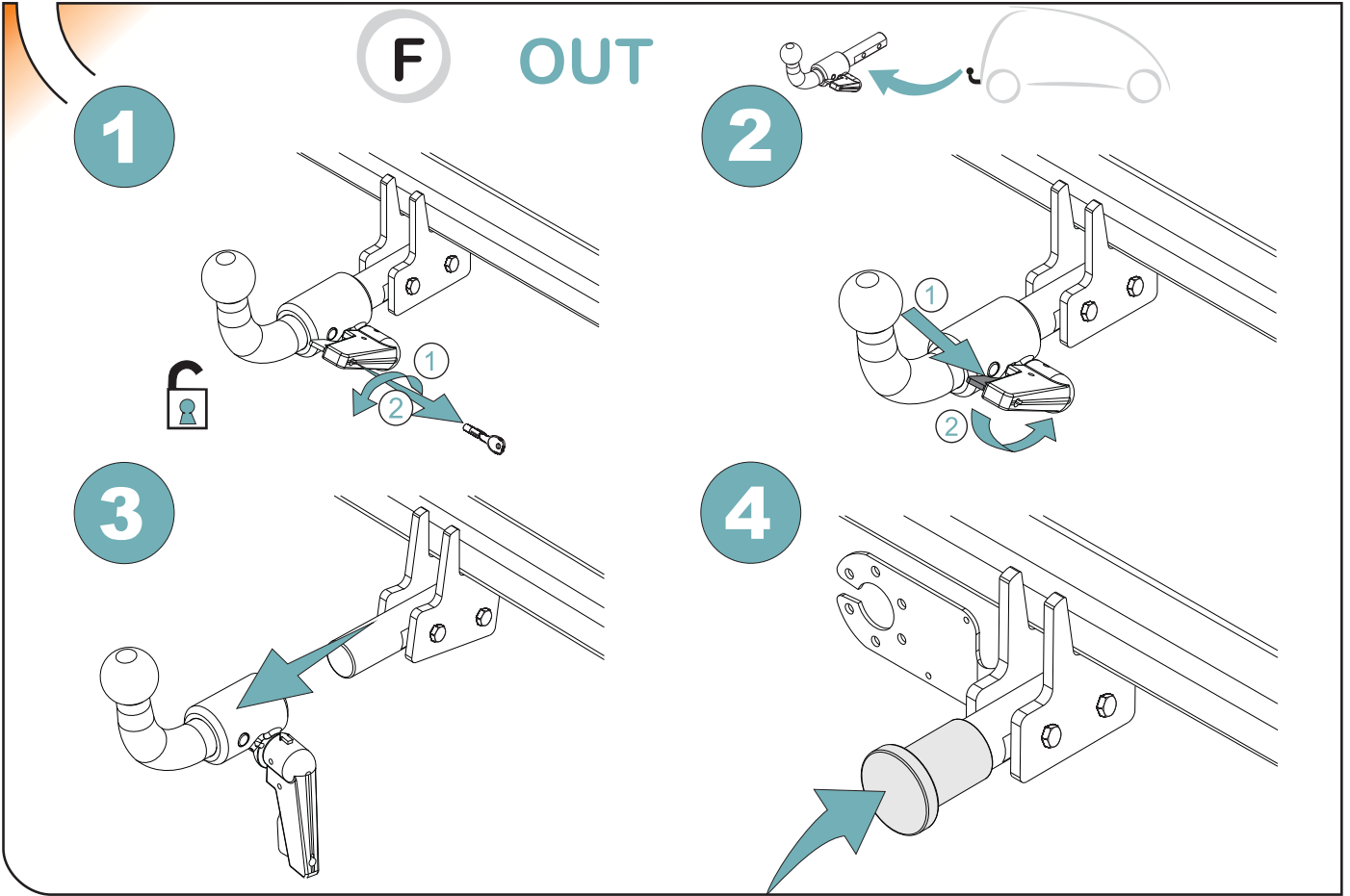

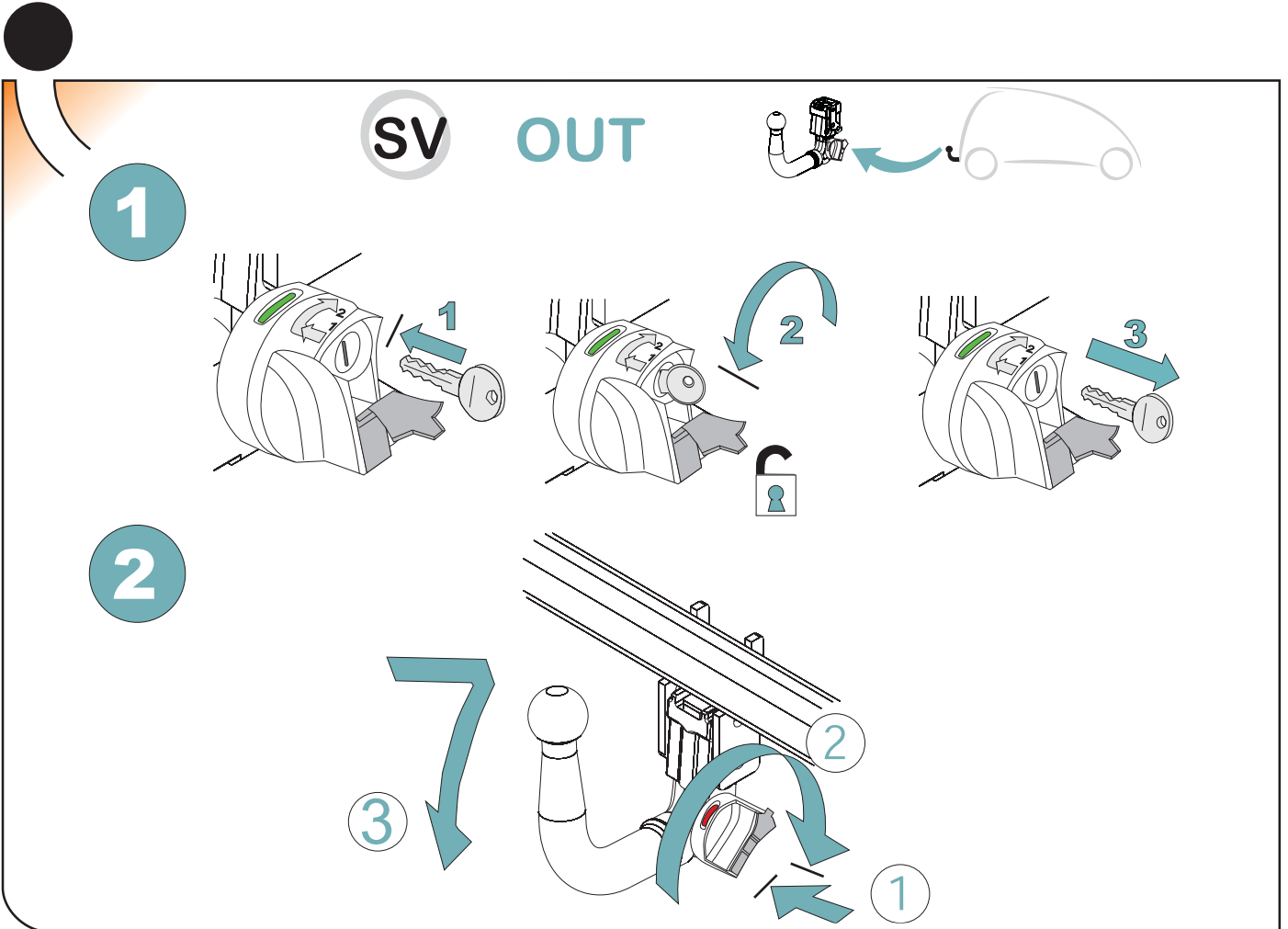
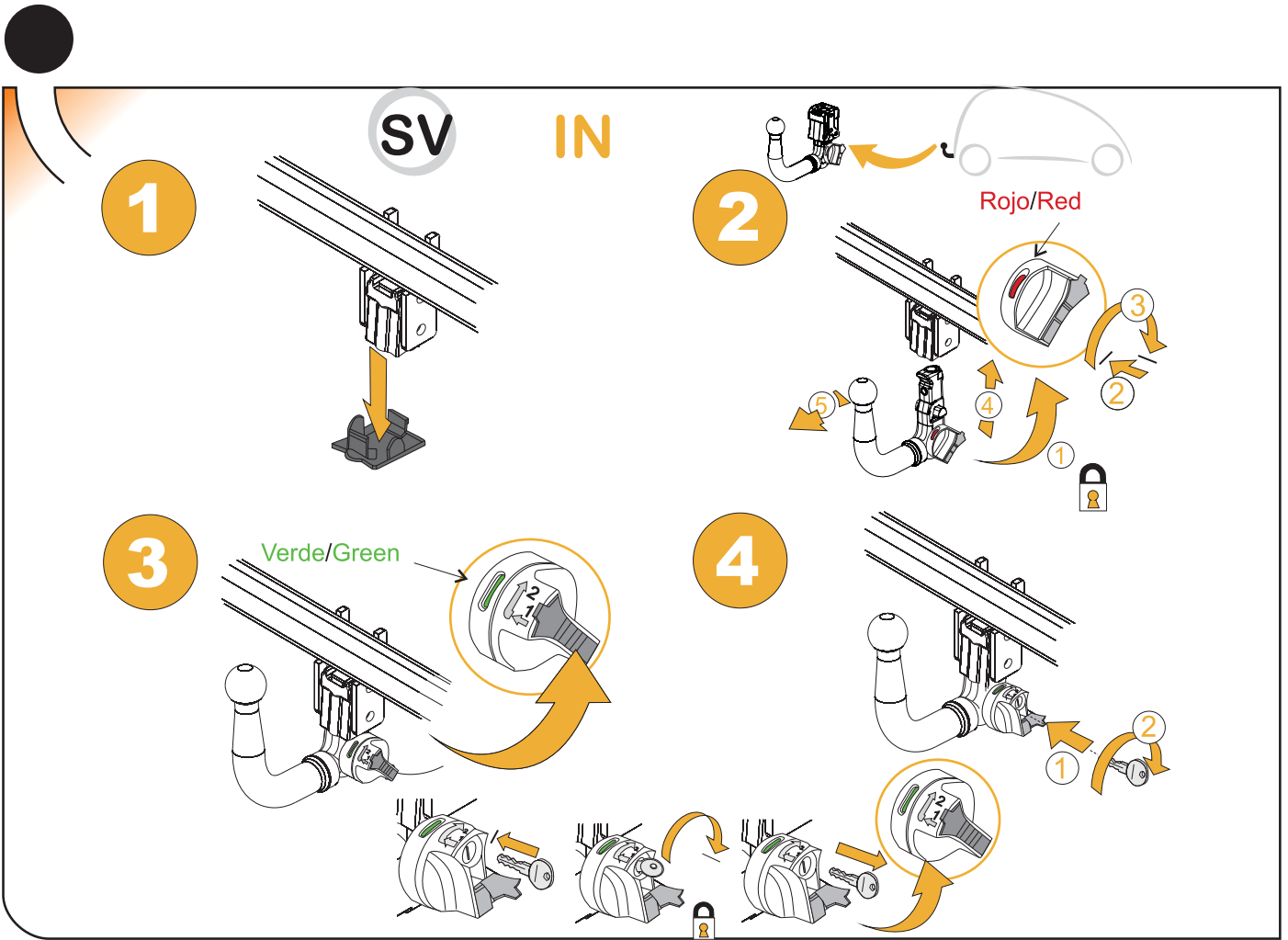

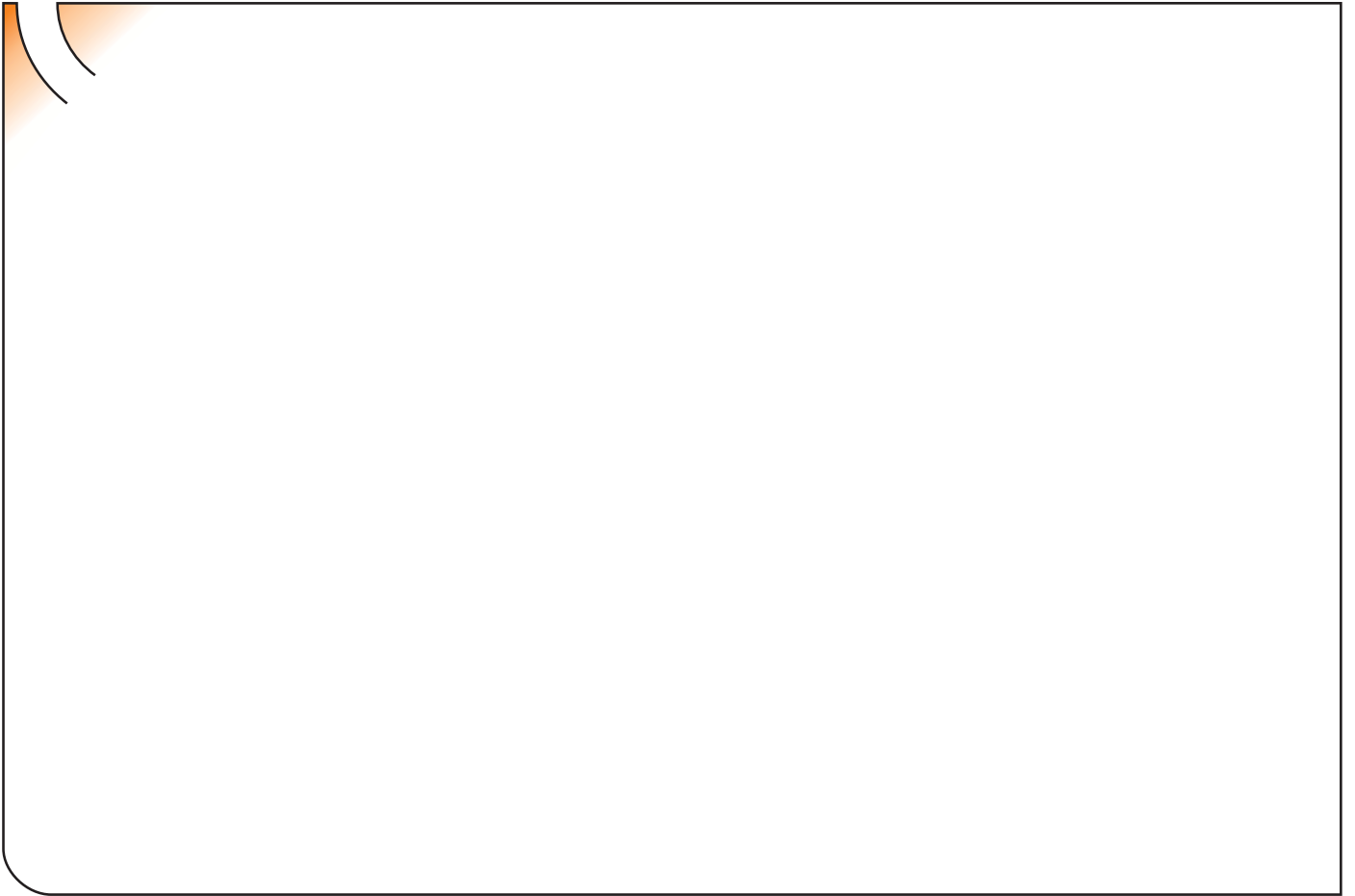

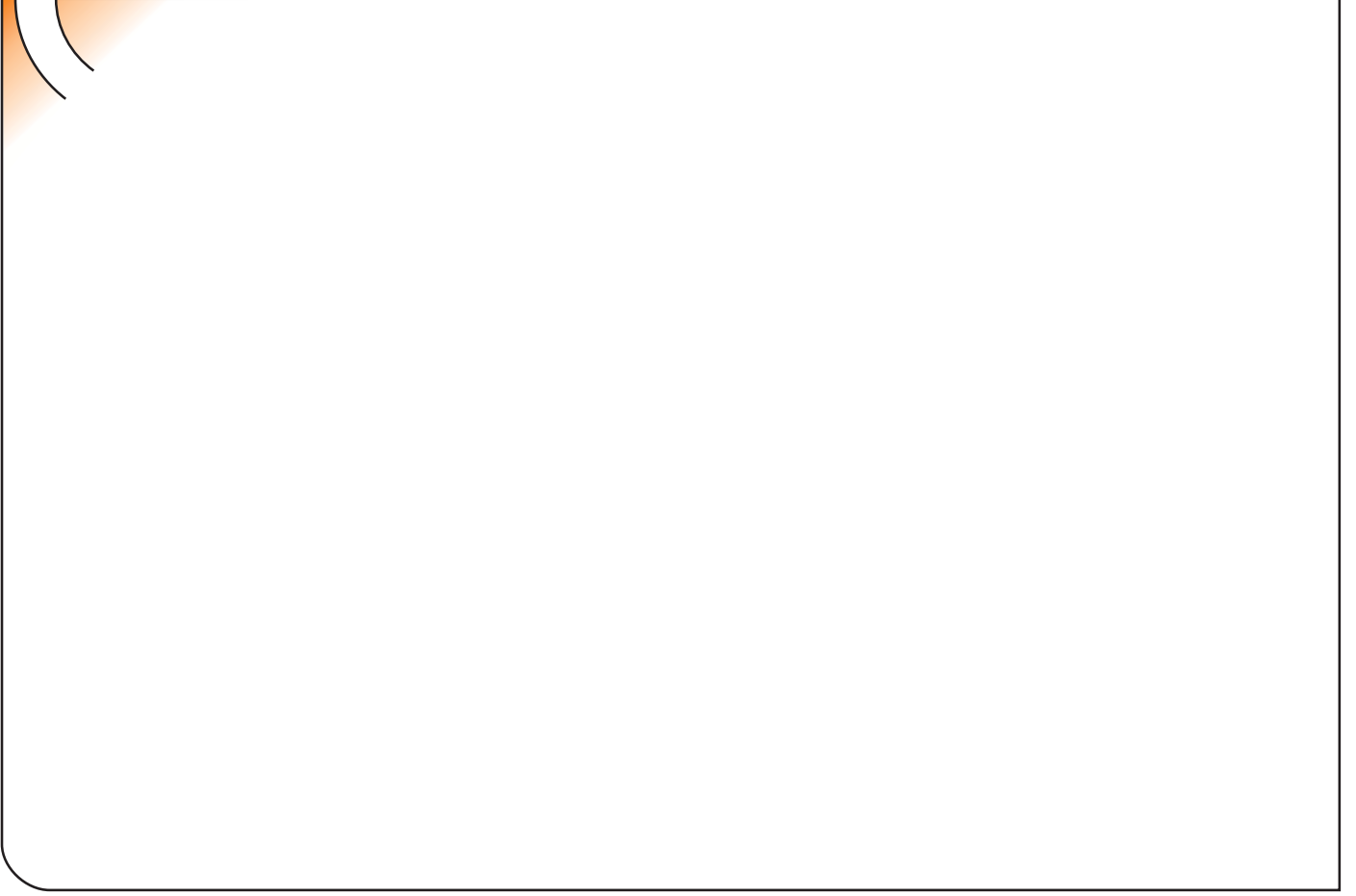
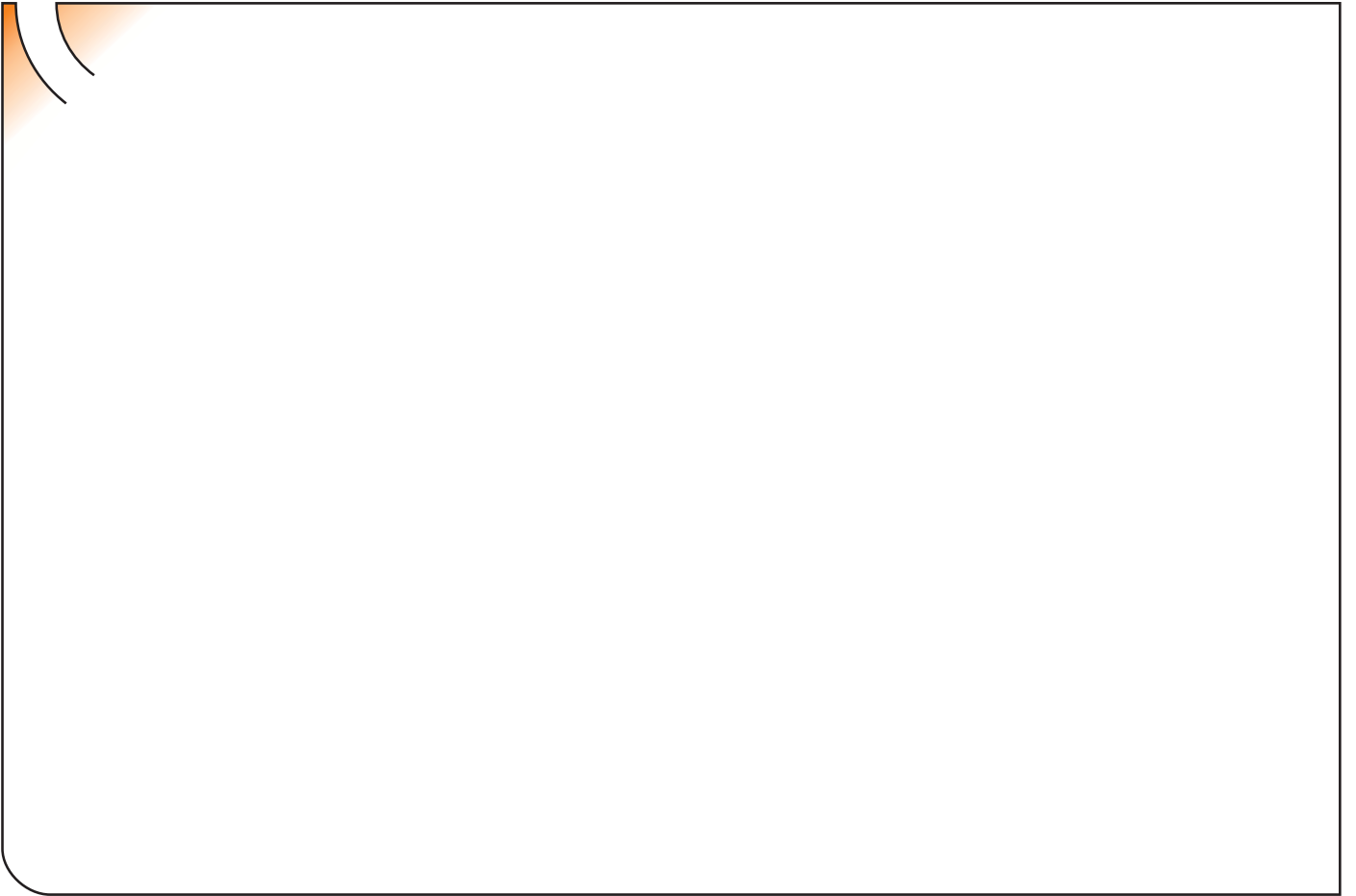

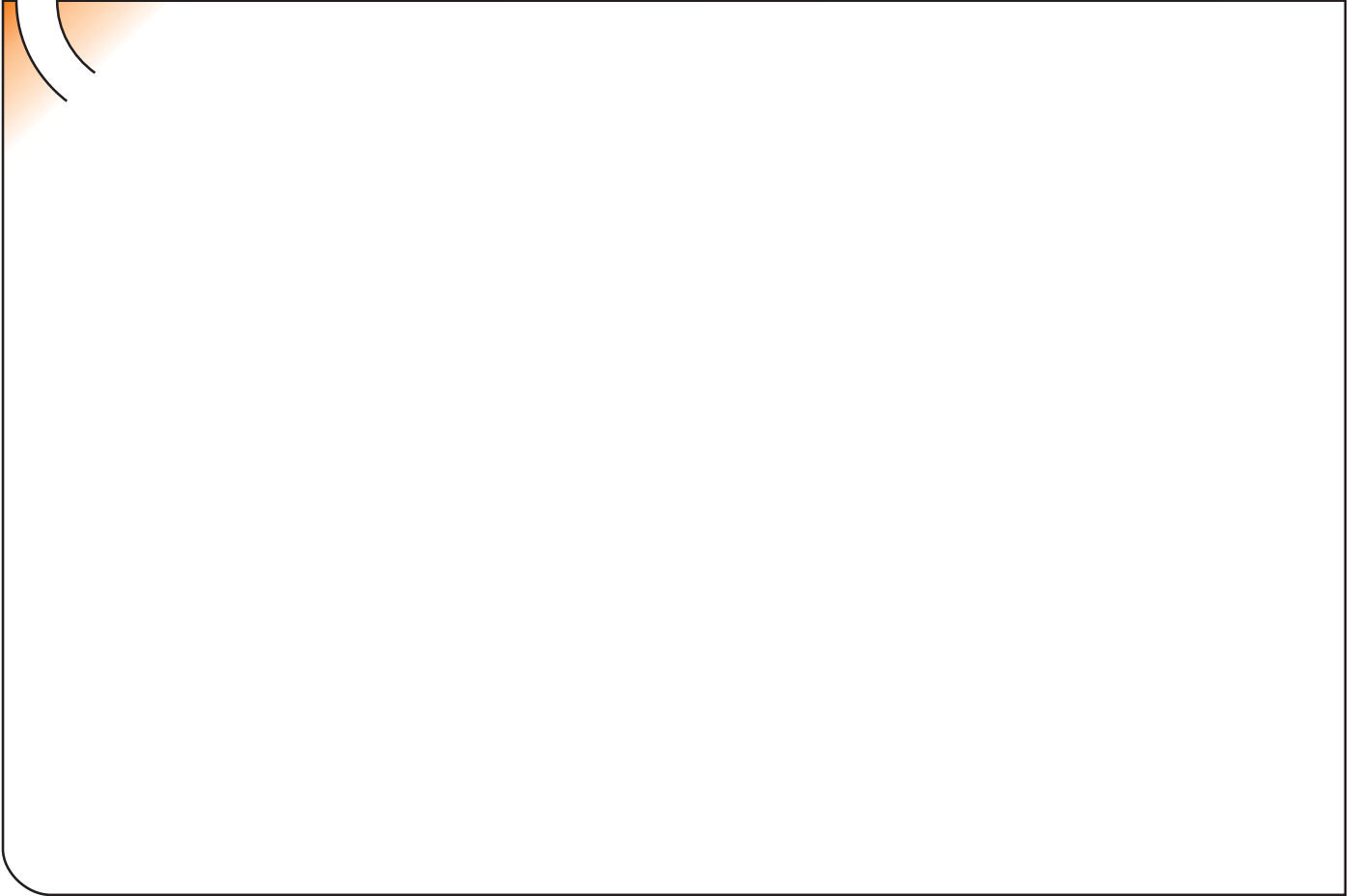
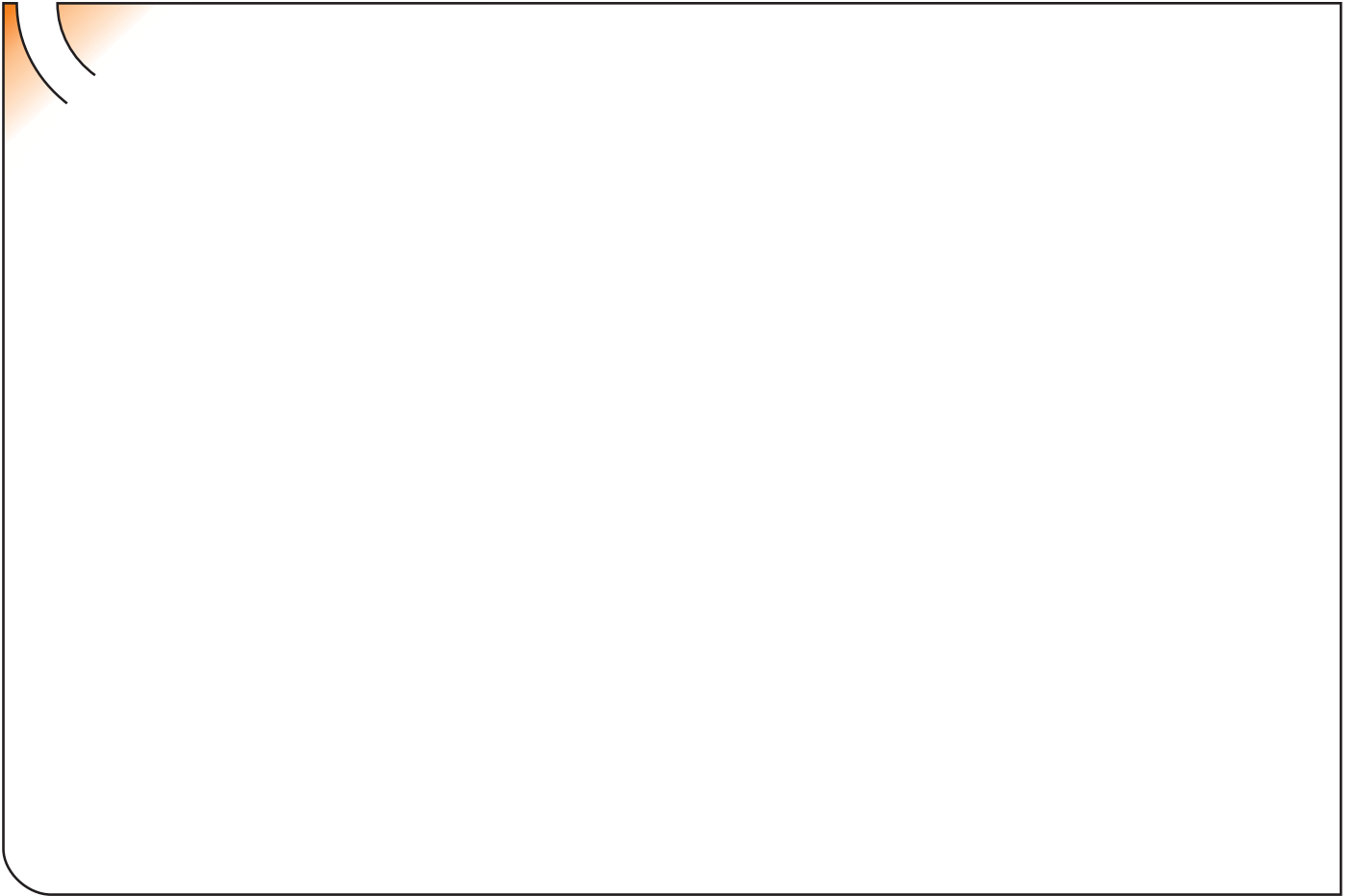

ANEXO III

CERTIFICADO DE TALLER

D. _____, expresamente autorizado por la _____
domiciliada en _____, teléfono _____, dedicada
a la actividad de _____ n° de Registro Industrial _____ y n° de registro
especial _____.

CERTIFICA

Que la mencionada empresa ha realizado la/s Reforma/s y asume la responsabilidad de la ejecución,
sobre el vehículo marca....., tipo.....
variante..... denominación comercial
matrícula y n° de bastidor, de acuerdo con:

- La normativa vigente en materia de reformas de vehículos.
- Las normas del fabricante del vehículo aplicables a la/s reforma/s llevadas a cabo en dicho vehículo.
- El proyecto descriptivo de la/s reforma/s, adjunto al expediente.

OBSERVACIONES: (2)

Tipificada/s con el código de reforma/s.....
Reforma consiste en:

COLOCACION DE ENGANCHE _____

n° de identificación / marca de homologación

Type :

Fecha:

Firma y sello:

Fdo:

(1) En el caso de que la reforma sea efectuada por el fabricante se indicará N/A.

(2) Se debe especificar en este apartado OBSERVACIONES, la identificación de los equipos o sistemas modificados, garantizando que se cumple lo previsto en el artículo 6 del reglamento general de vehículos y, en su caso, en el artículo 5 del R. D. 1457/1986 de 10 de enero, por el que se regula la actividad industrial en talleres de vehículos automóviles, de equipos y sus componentes, modificado por 455/2010 de 16 de abril, por el que se modifica el R. D. 1457/1986 de 10 de enero por el que se regulan la actividad industrial y la prestación.

ES

1



2

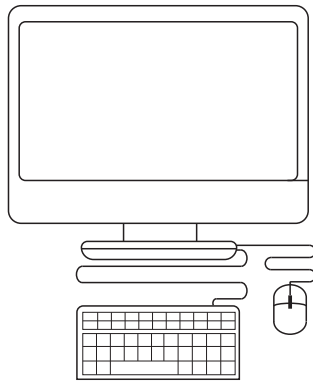

3



IT

1

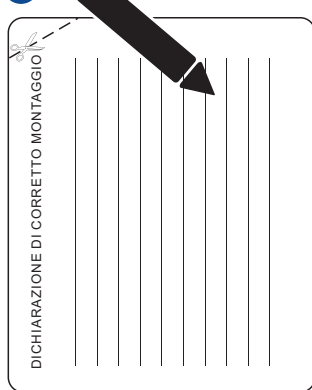

2

