

**Mitsubishi ASX (2010- )**  
**Peugeot 4008 (2012- )**  
**Citroen C4 Aircross (2012- )**  
**Mitsubishi Eclipse Cross (2018- )**



Nº Revisión | Fecha Aprobación  
Nº 007 | 02-03-2018



94/20/EC

Mitsubishi ASX (2010-)  
 Peugeot 4008 (2012-)  
 Citroën C4 Aircross (2012-)  
 Mitsubishi Eclipse Cross (2018-)

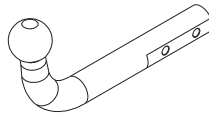

e13	APPROVALNUMBER	D-VALUE
	00-3287	D 8,67 kN
	TYPE	CLASS
	MIT023	A50-X
		MAX.VERT.LOAD
		S 105 kg

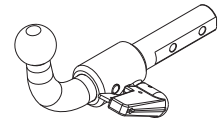

e13	APPROVALNUMBER	D-VALUE
	00-3288	D 8,67 kN
	TYPE	CLASS
	MIT024-S	A50-X
		MAX.VERT.LOAD
		S 105 kg

D= 8,67 kN



T= 1500 Kg



S = 105 kg

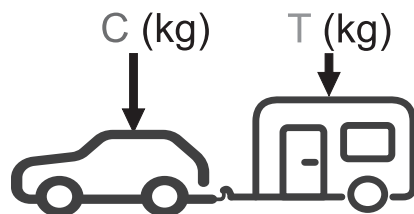
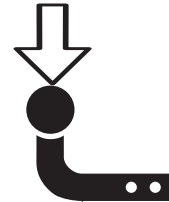

$g = 9,81 \text{ m/s}^2$

$$D \geq \frac{T \cdot C}{T+C} \cdot \frac{g}{1000} \text{ (kN)}$$





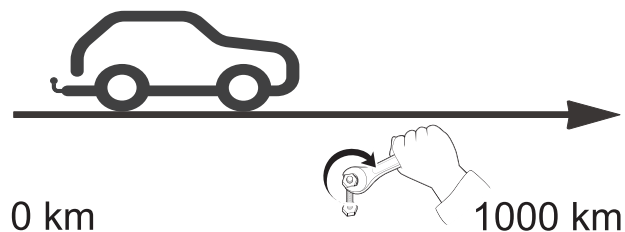

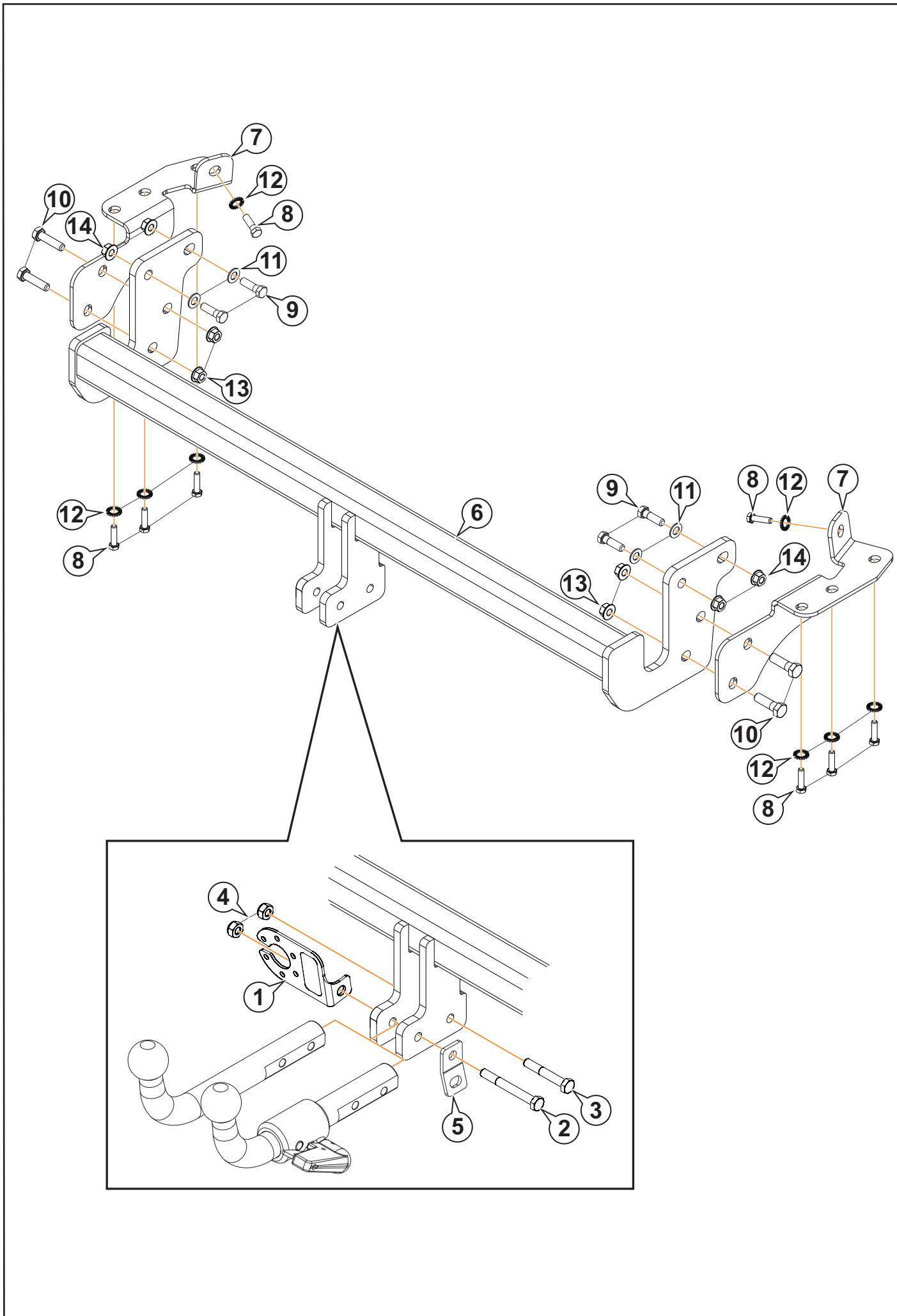

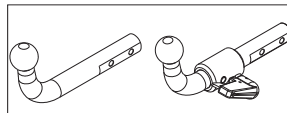





$$T \leq \frac{C \cdot D \cdot 1000}{(C \cdot g) - (1000 \cdot D)} \text{ (kg)}$$

	M8	M10	M12	M14	M16
N/m	20	40	60	105	160







1		AEV0005	1	
2		M10x70 DIN 931(8.8)	1	
3		M10x65 DIN 931(8.8)	1	
4		M10 DIN 980	2	
5		AEV0006	1	
6		C4209A	1	
7		C4209AA22	1+1	
8		M10x1,25x30 DIN 961(8.8)	8	
9		M12x110 DIN 933(8.8)	4	
10		M10x35 DIN 933(8.8)	4	
11		Ø12 DIN 9021	4	
12		Ø10 DIN 6798	8	
13		M10 DIN 6923	4	
14		M12 DIN 6923	4	

1

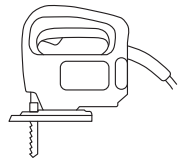
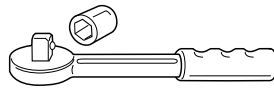
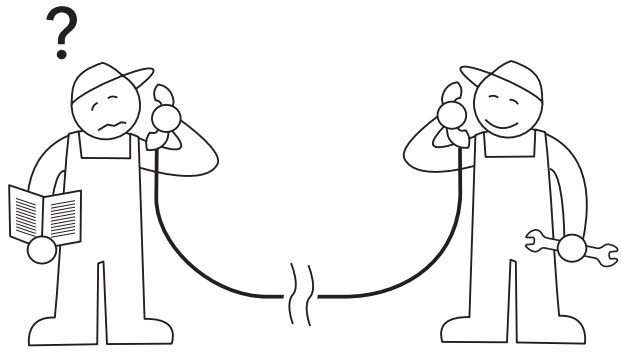
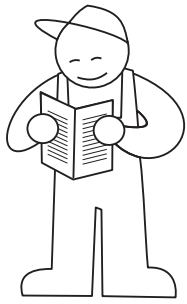

2

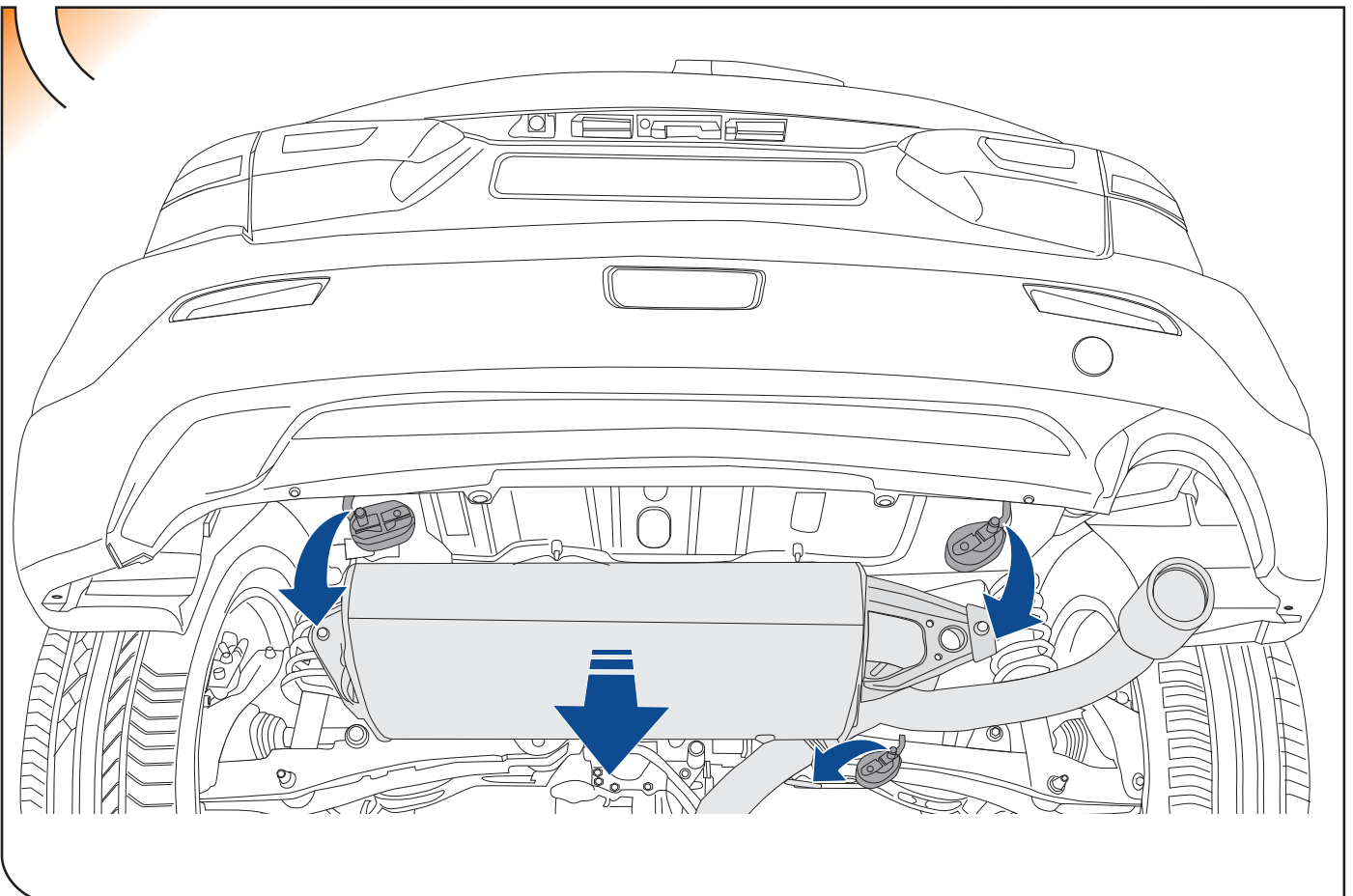

3

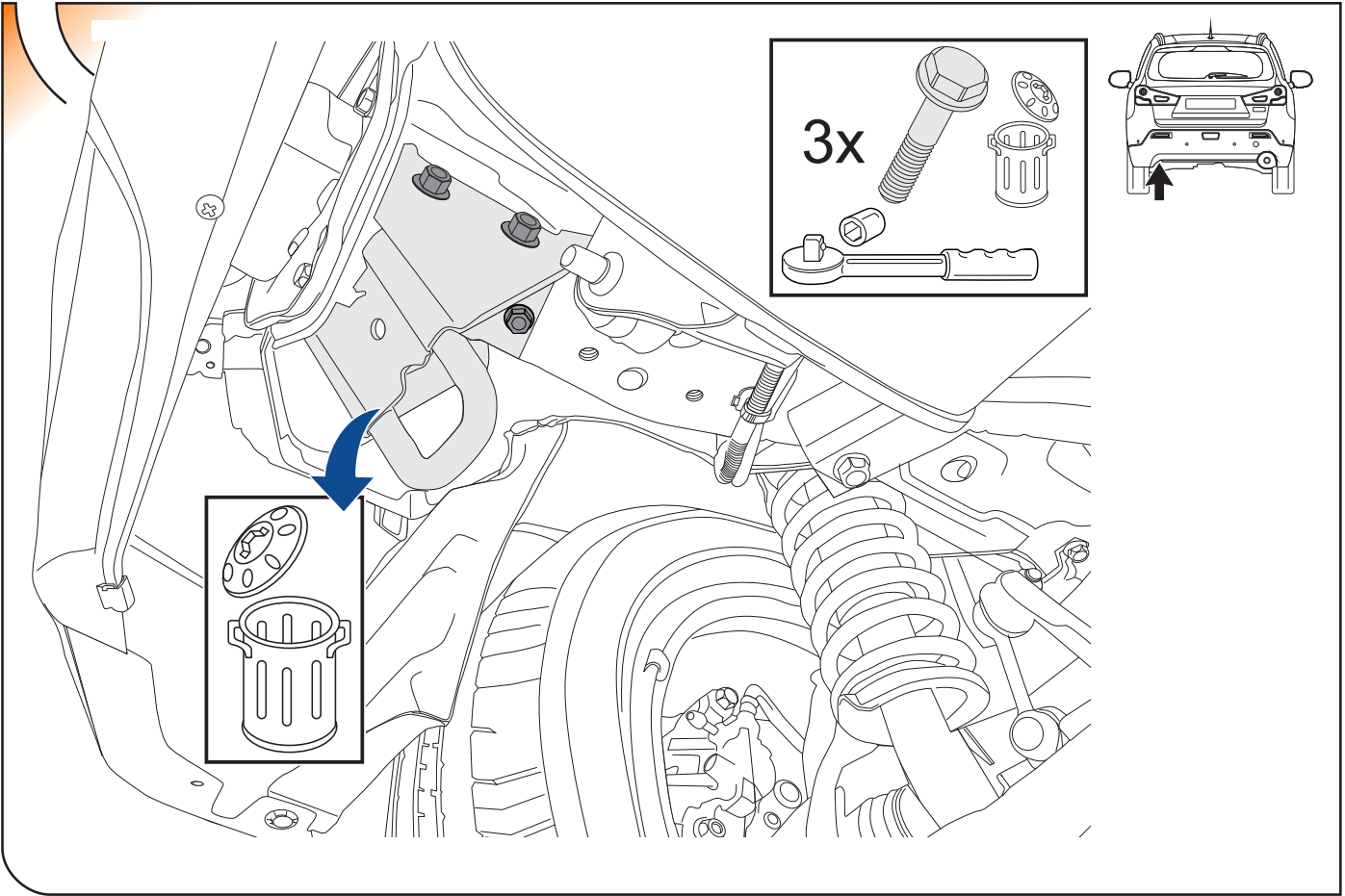

4

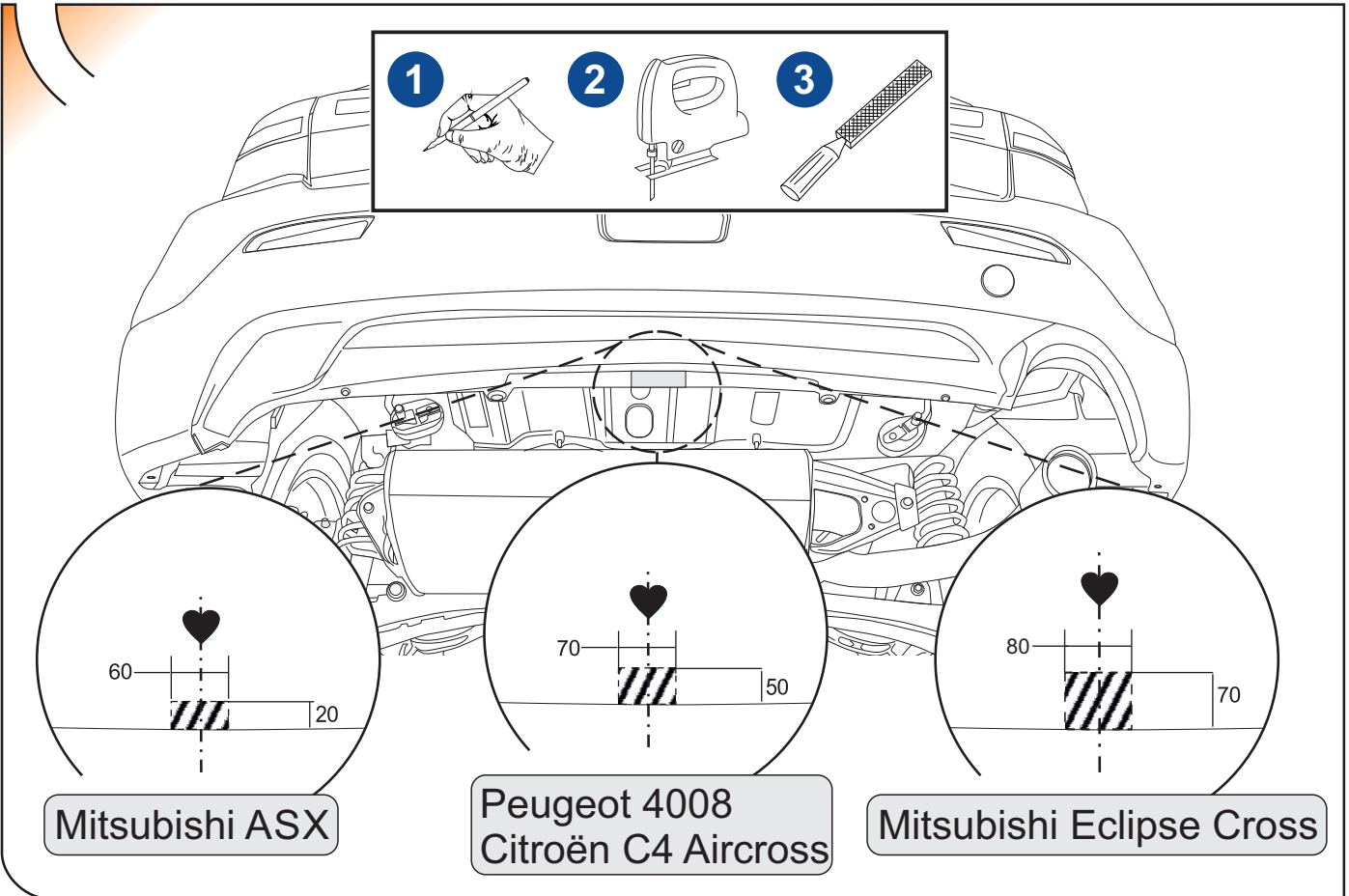

5

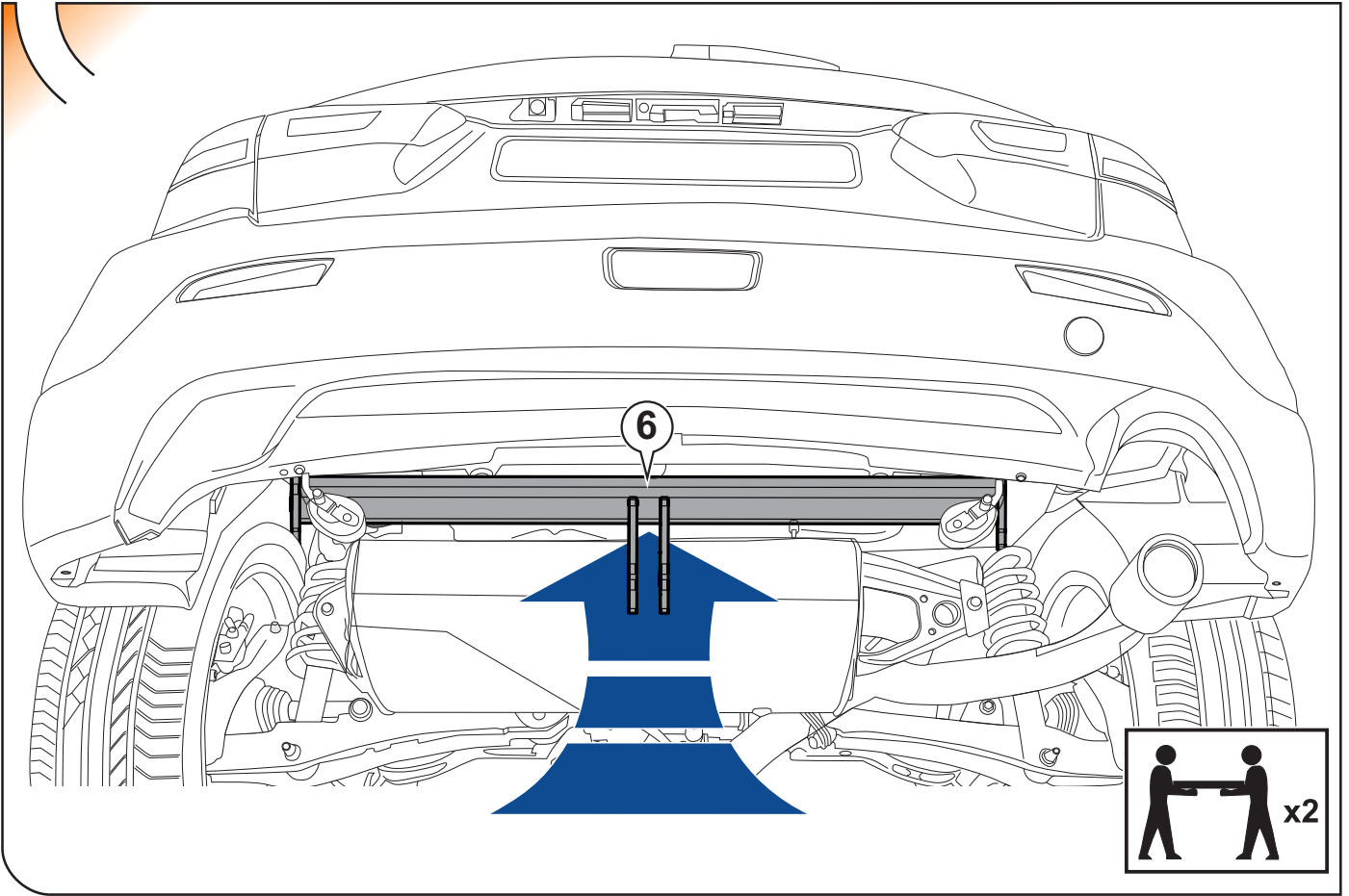

6

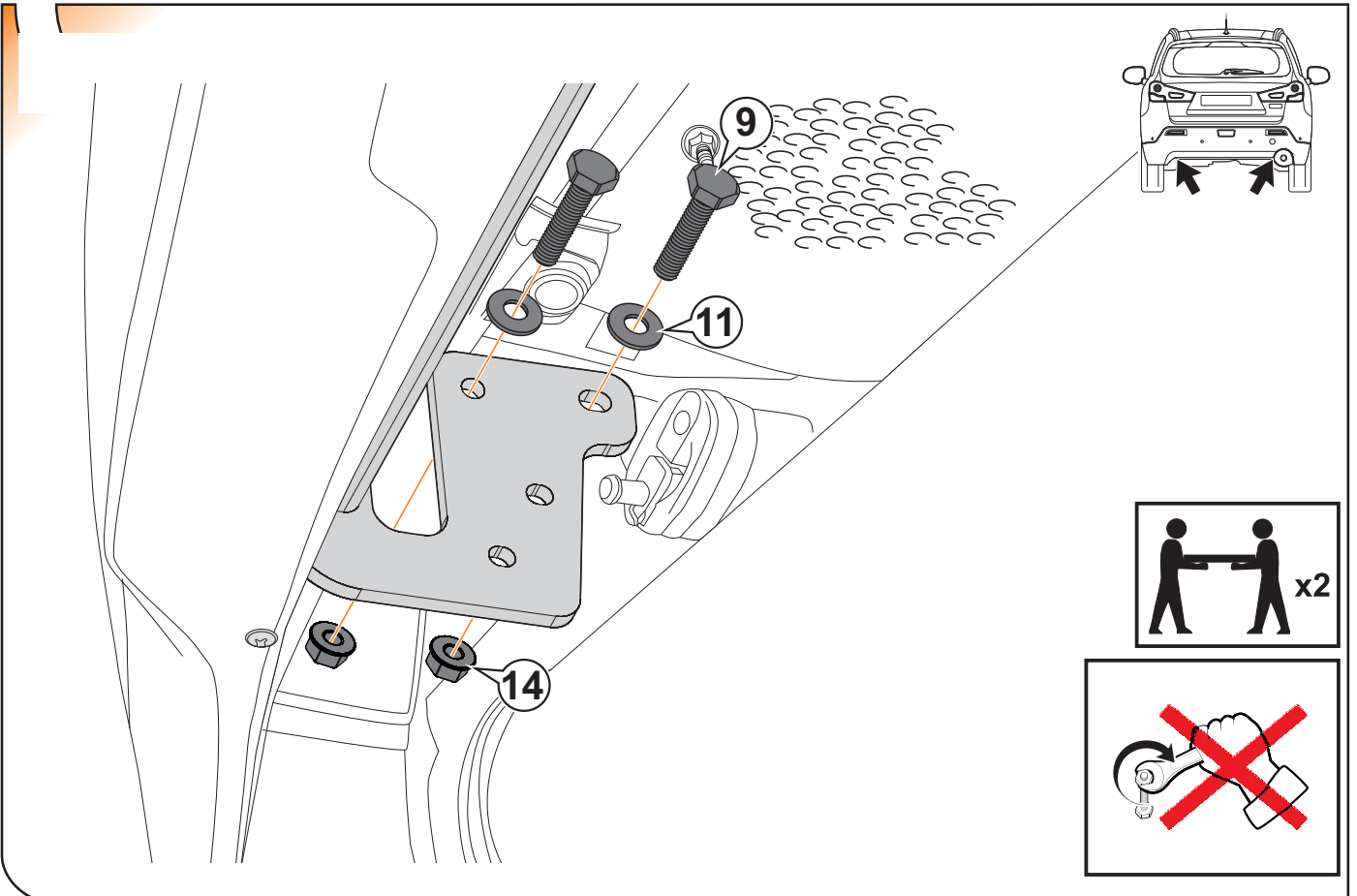



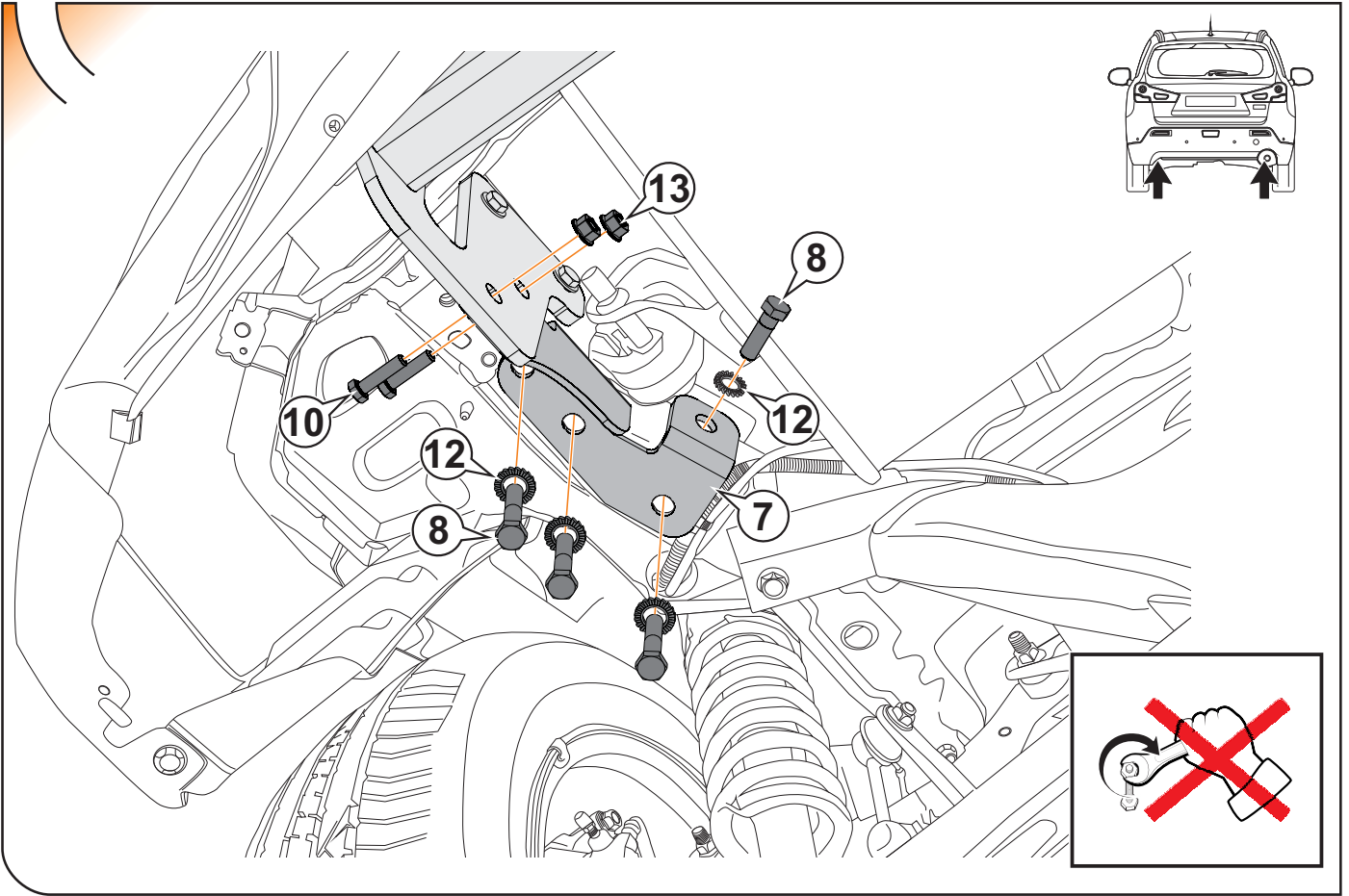

7



8

	M8	M10	M12	M14	M16
N/m	20	40	60	105	160

 

Nm

9

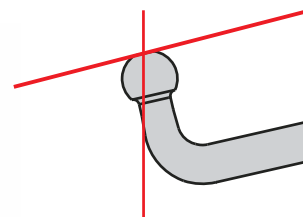
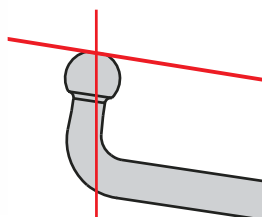
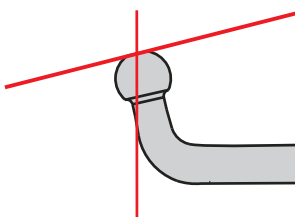
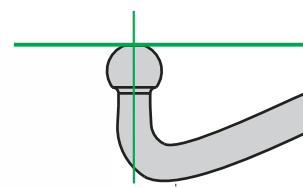
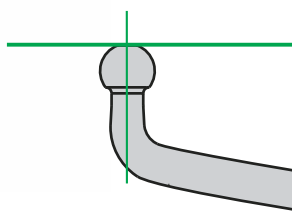
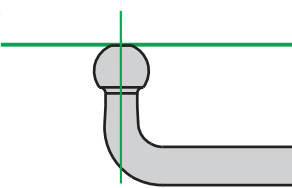
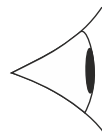
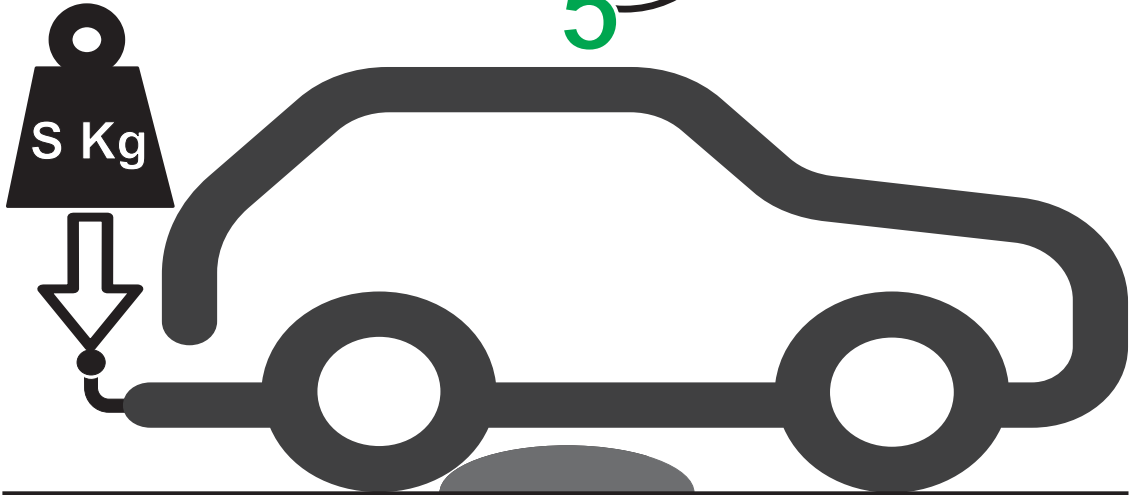
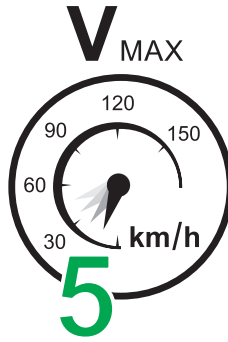

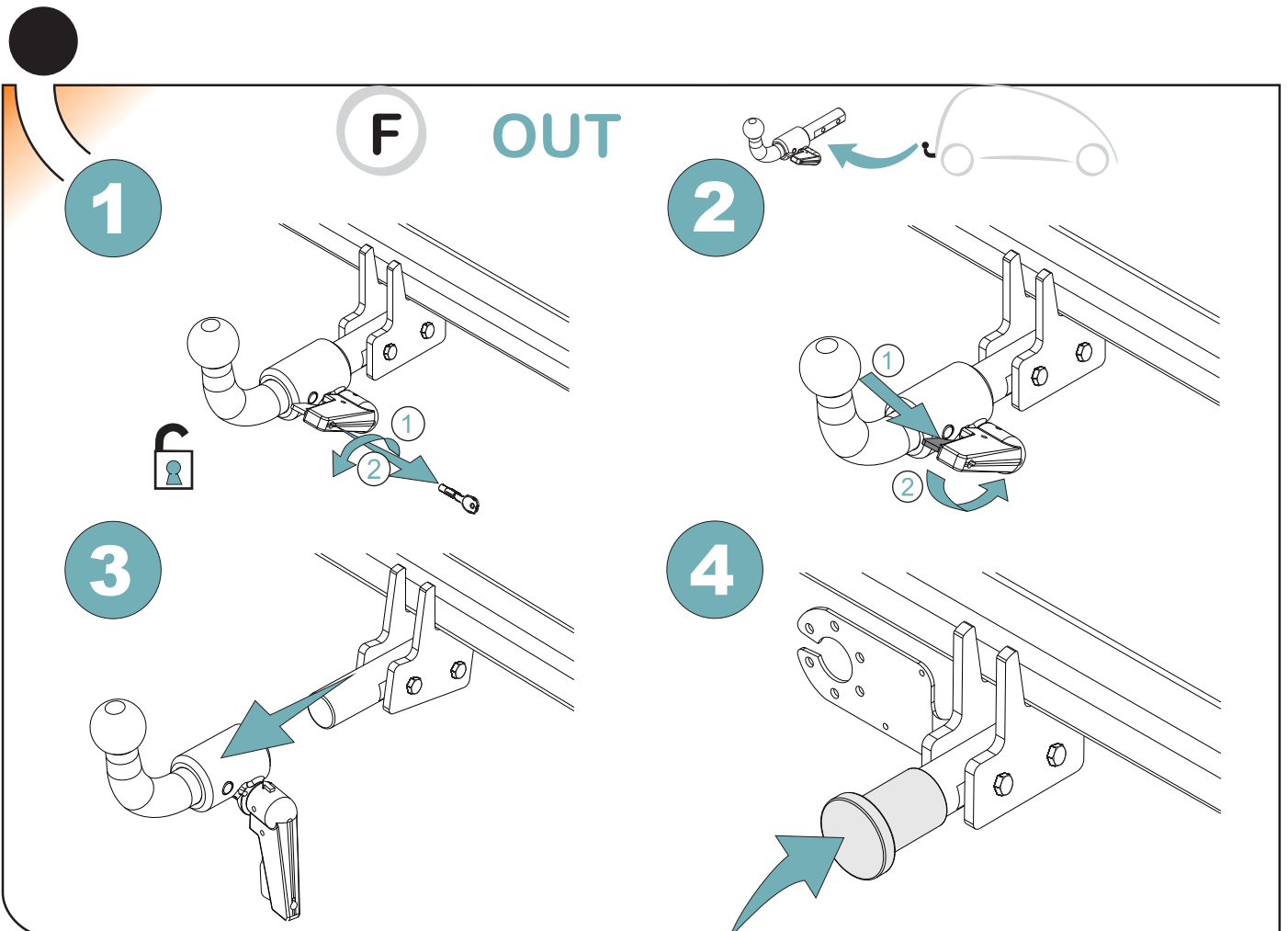
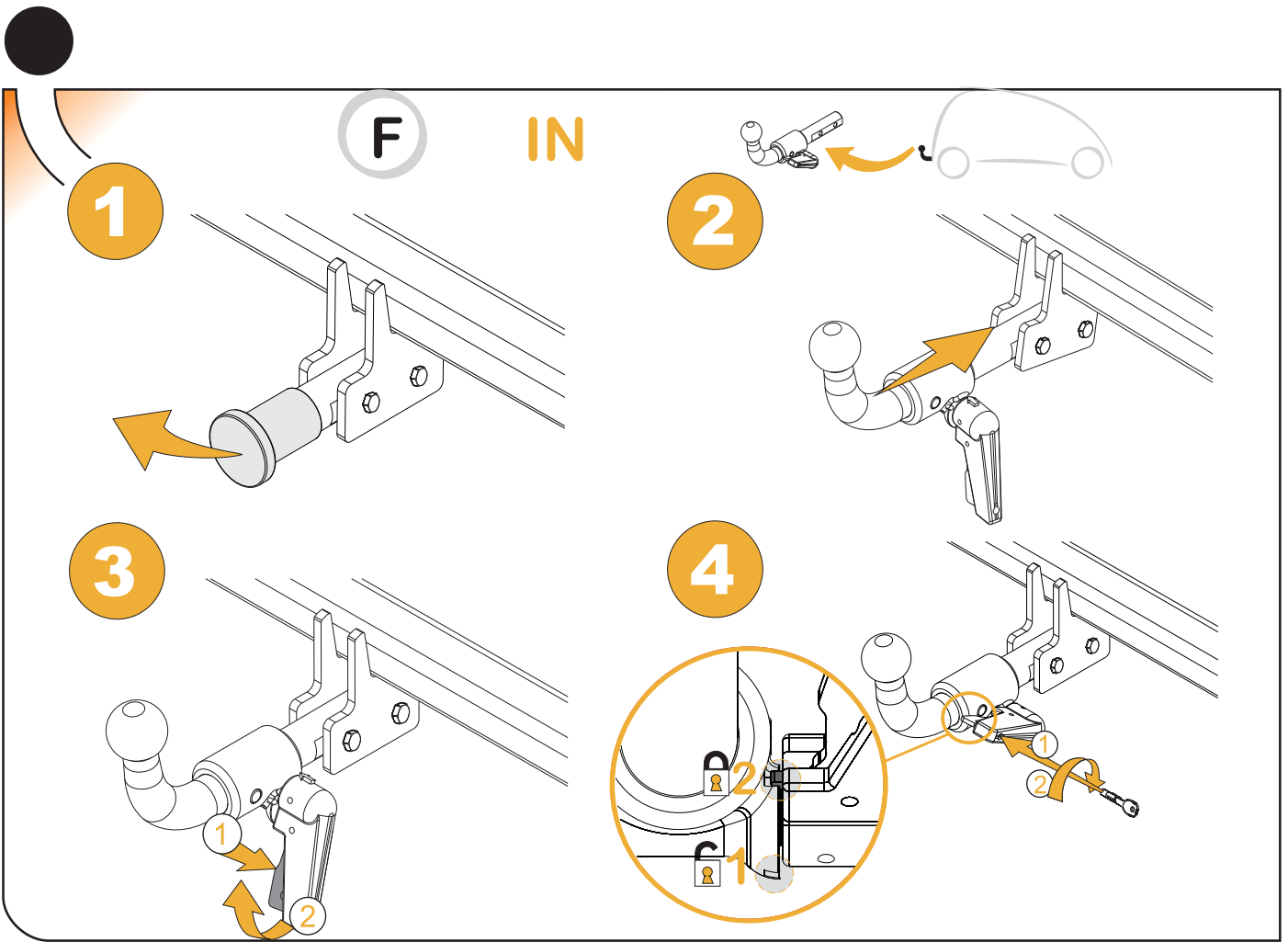

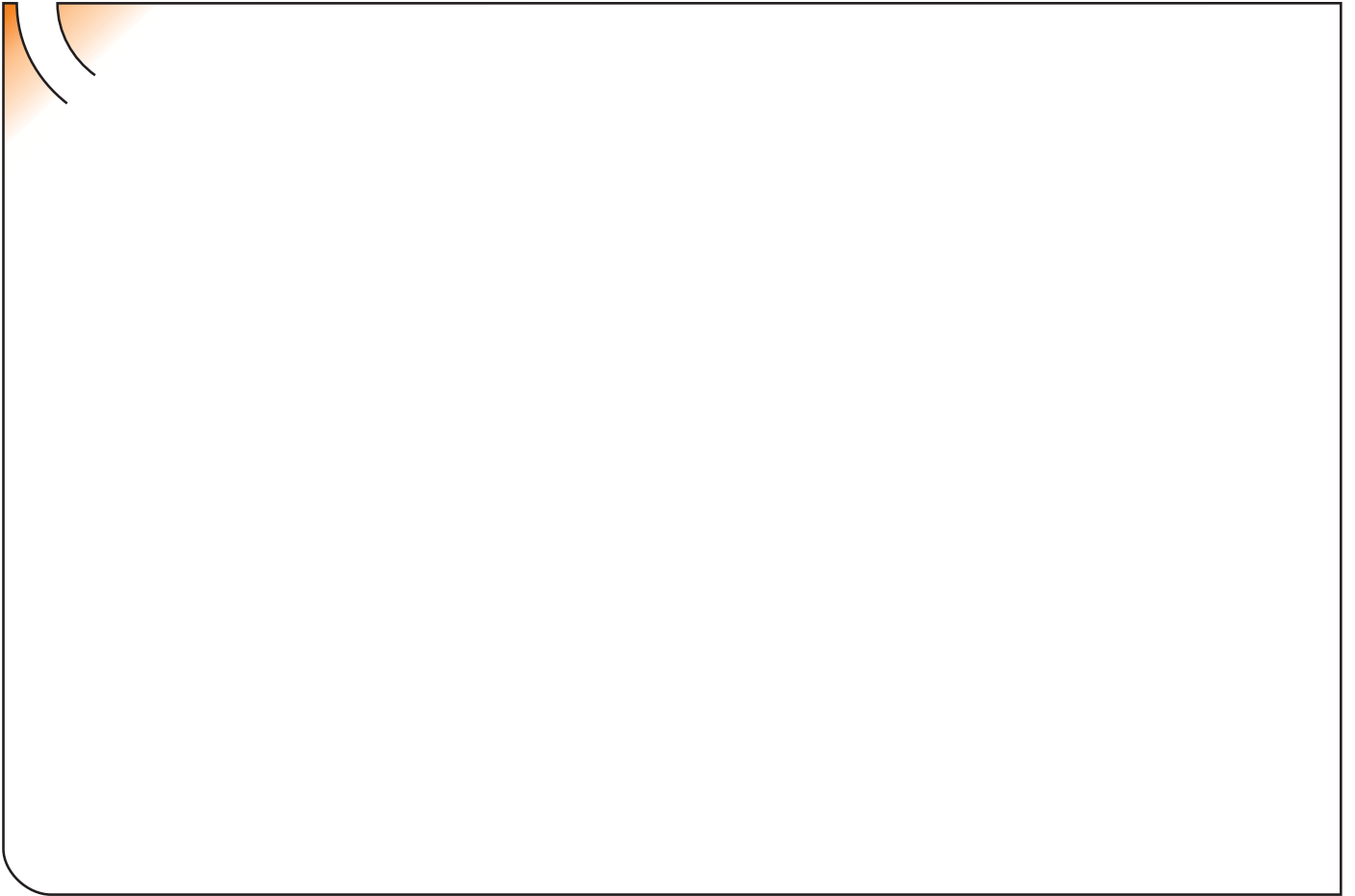

## ANEXO III

### CERTIFICADO DE TALLER

D. \_\_\_\_\_, expresamente autorizado por la \_\_\_\_\_  
domiciliada en \_\_\_\_\_, teléfono \_\_\_\_\_, dedicada  
a la actividad de \_\_\_\_\_ n° de Registro Industrial \_\_\_\_\_ y n° de registro  
especial \_\_\_\_\_.

#### CERTIFICA

Que la mencionada empresa ha realizado la/s Reforma/s y asume la responsabilidad de la ejecución,  
sobre el vehículo marca....., tipo.....  
variante..... denominación comercial .....  
matrícula ..... y n° de bastidor ....., de acuerdo con:

- La normativa vigente en materia de reformas de vehículos.
- Las normas del fabricante del vehículo aplicables a la/s reforma/s llevadas a cabo en dicho vehículo.
- El proyecto descriptivo de la/s reforma/s, adjunto al expediente.

#### OBSERVACIONES: (2)

Tipificada/s con el código de reforma/s.....  
Reforma consiste en:

COLOCACION DE ENGANCHE \_\_\_\_\_

n° de identificación / marca de homologación

Type :

Fecha:

Firma y sello:

Fdo:

(1) En el caso de que la reforma sea efectuada por el fabricante se indicará N/A.

(2) Se debe especificar en este apartado OBSERVACIONES, la identificación de los equipos o sistemas modificados, garantizando que se cumple lo previsto en el artículo 6 del reglamento general de vehículos y, en su caso, en el artículo 5 del R. D. 1457/1986 de 10 de enero, por el que se regula la actividad industrial en talleres de vehículos automóviles, de equipos y sus componentes, modificado por 455/2010 de 16 de abril, por el que se modifica el R. D. 1457/1986 de 10 de enero por el que se regulan la actividad industrial y la prestación.

**ES**

1

ANEXO III  
CERTIFICADO DE TALLER

2

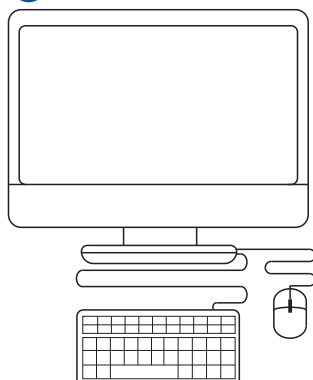

3



**IT**

1

DICHIARAZIONE DI CORRETTO MONTAGGIO

2

