

Citroën C3 Aircross (2017-)

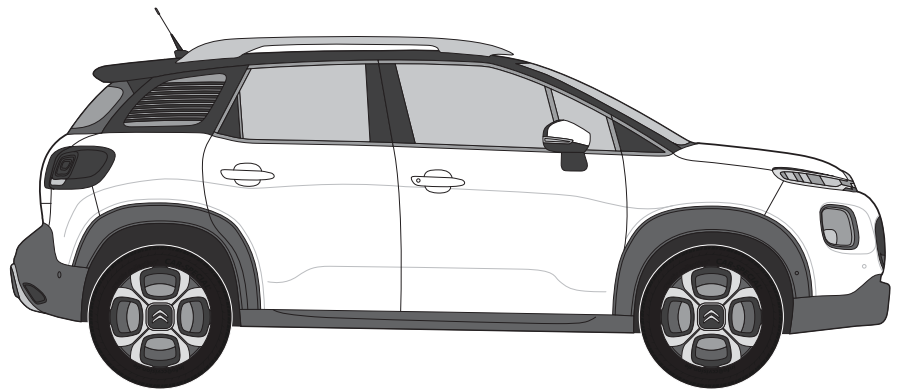

ECE/R55

Citroën C3 Aircross (2017-)

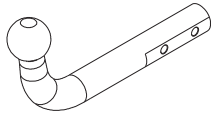

E13 APPROVALNUMBER: 55R-01 4432 D-VALUE: 7,6 kN
 TYPE: CTR050 CLASS: A50-X MAX.VERT.LOAD: 75 kg

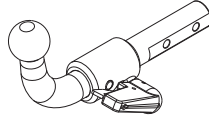

E13 APPROVALNUMBER: 55R-01 4433 D-VALUE: 7,6 kN
 TYPE: CTR051-S CLASS: A50-X MAX.VERT.LOAD: 75 kg

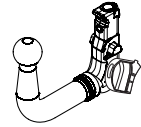

E13 APPROVALNUMBER: 55R-01 4433 D-VALUE: 7,6 kN
 TYPE: CTR051-V CLASS: A50-X MAX.VERT.LOAD: 75 kg

D = 7,6 kN



T = 1265 Kg



S = 75 kg

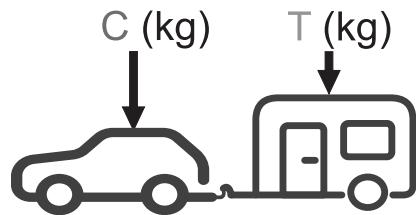
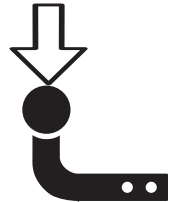

$g = 9,81 \text{ m/s}^2$

$$D \geq \frac{T \cdot C}{T + C} \cdot \frac{g}{1000} \text{ (kN)}$$





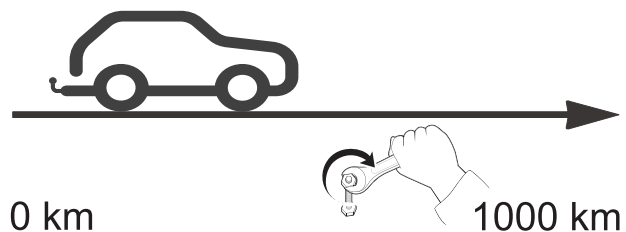

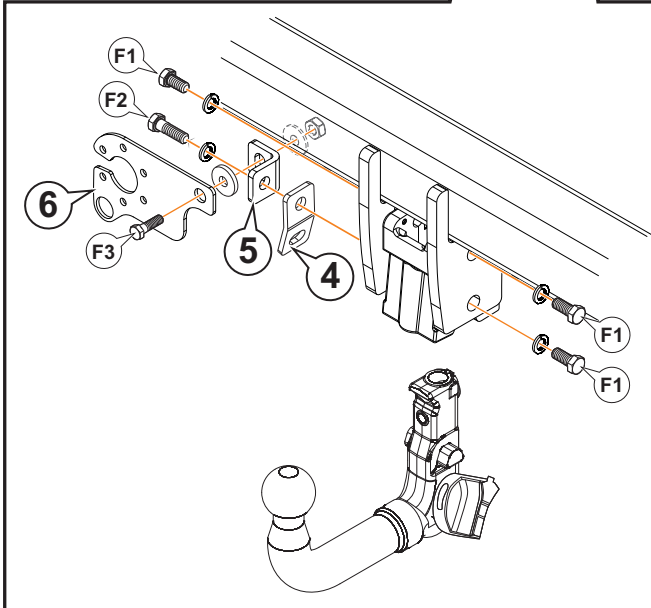
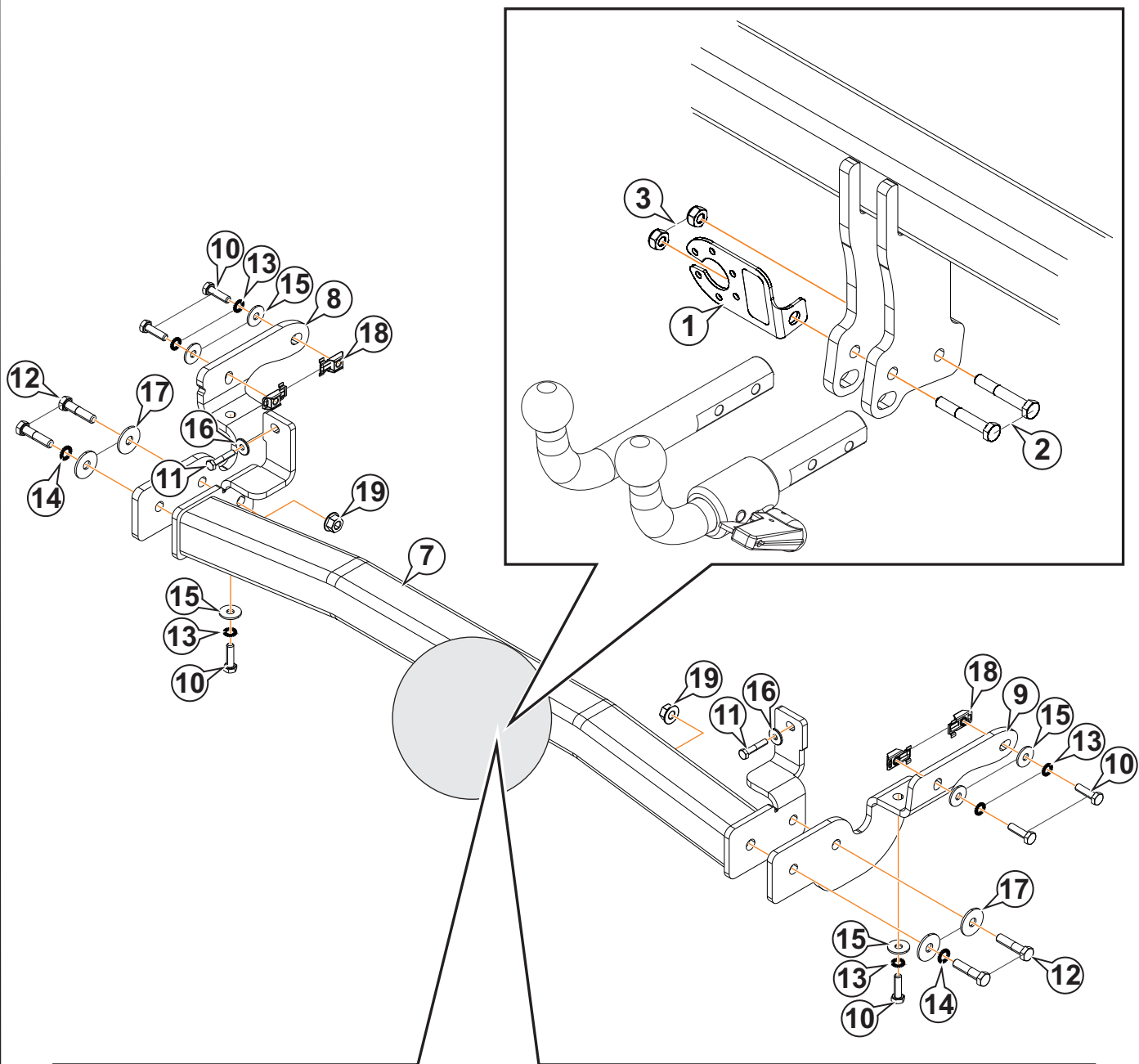



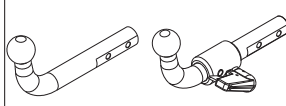
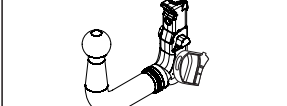

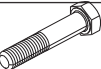

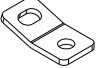
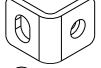

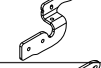
$$T \leq \frac{C \cdot D \cdot 1000}{(C \cdot g) - (1000 \cdot D)} \text{ (kg)}$$

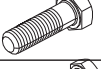
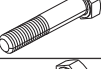
	M8	M10	M12	M14	M16
N/m	20	40	60	105	160





		#
F1	M12 x 25 DIN 933	3
	Ø12 Grower DIN 128	3
F2	M12 x 35 DIN 933	3
	Ø12 Grower DIN 128	1
F3	M10 x 30 DIN 933	1
	Ø10 Poliuretano / Nylon	1
	Ø10 DIN 9021	1
	M10 DIN 980	1

				
1		AEV0005	1	
2		M10x65 DIN 931	2	
3		M10 DIN 980	2	
4		AEV0006		1
5		AEV0008		1
6		AEV0009		1
7		C1229AA60	1	1
8		C1229AA22	1	1
9		C1229AA24	1	1
10		M10x35 DIN 933	6	1+1
11		M8x40 DIN 933	2	2
12		M12x50 DIN 933	4	4
13		Ø10 DIN 6798	6	6
14		Ø12 DIN 6798	2	2
15		Ø10 DIN 9021	6	6
16		Ø8 DIN 9021	2	2
17		Ø12 DIN 9021	4	4
18		M10 L44	4	4
19		M12 DIN 6923	2	2

1

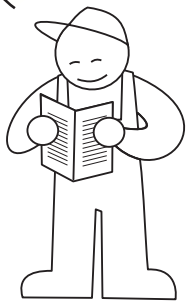

?

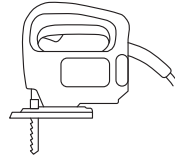
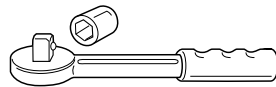
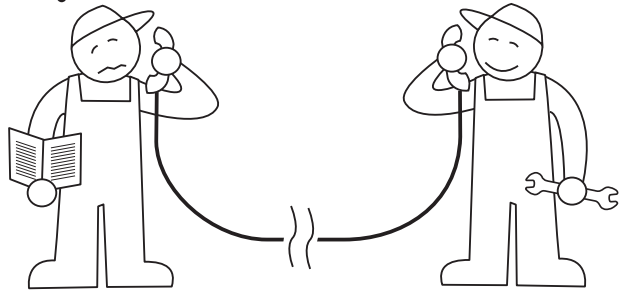

2

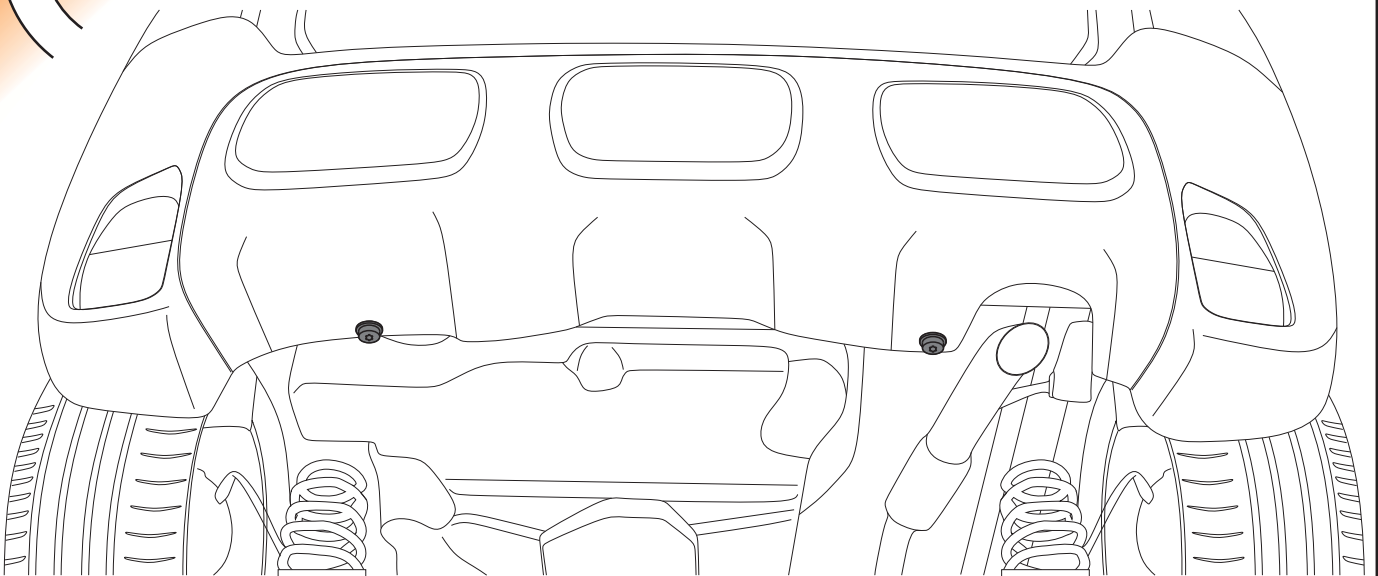

2x

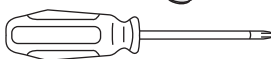

3

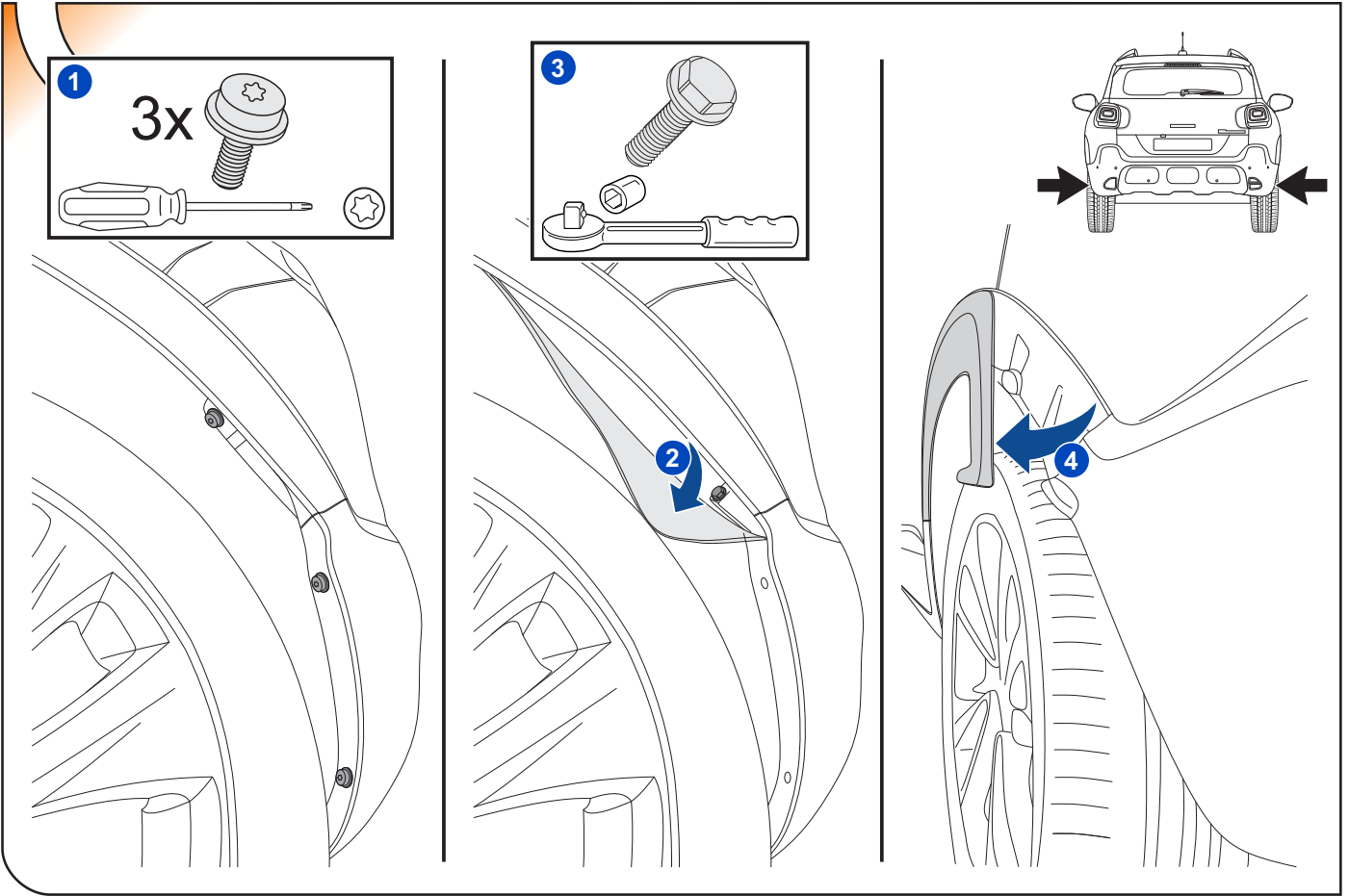

4

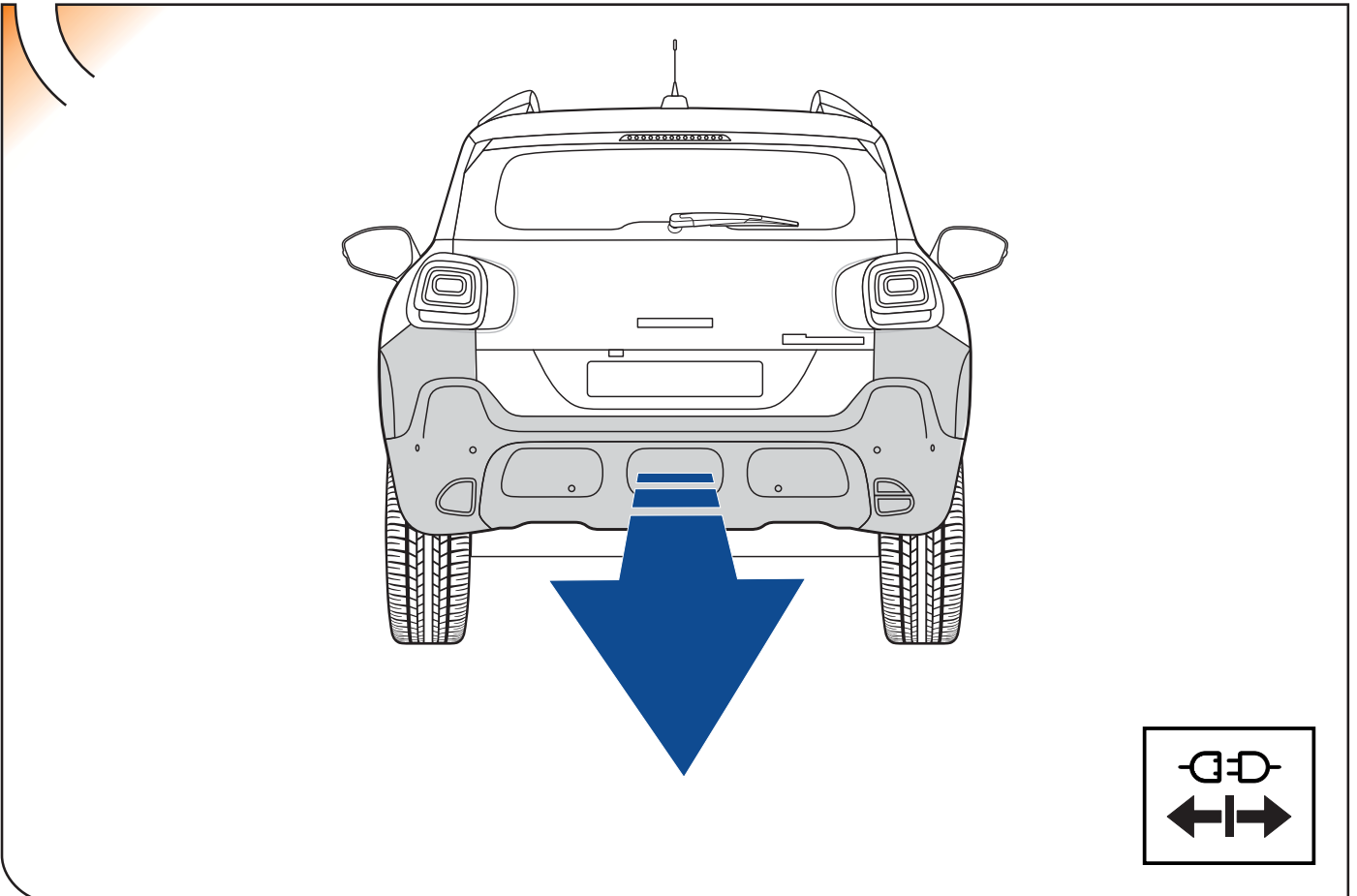

5

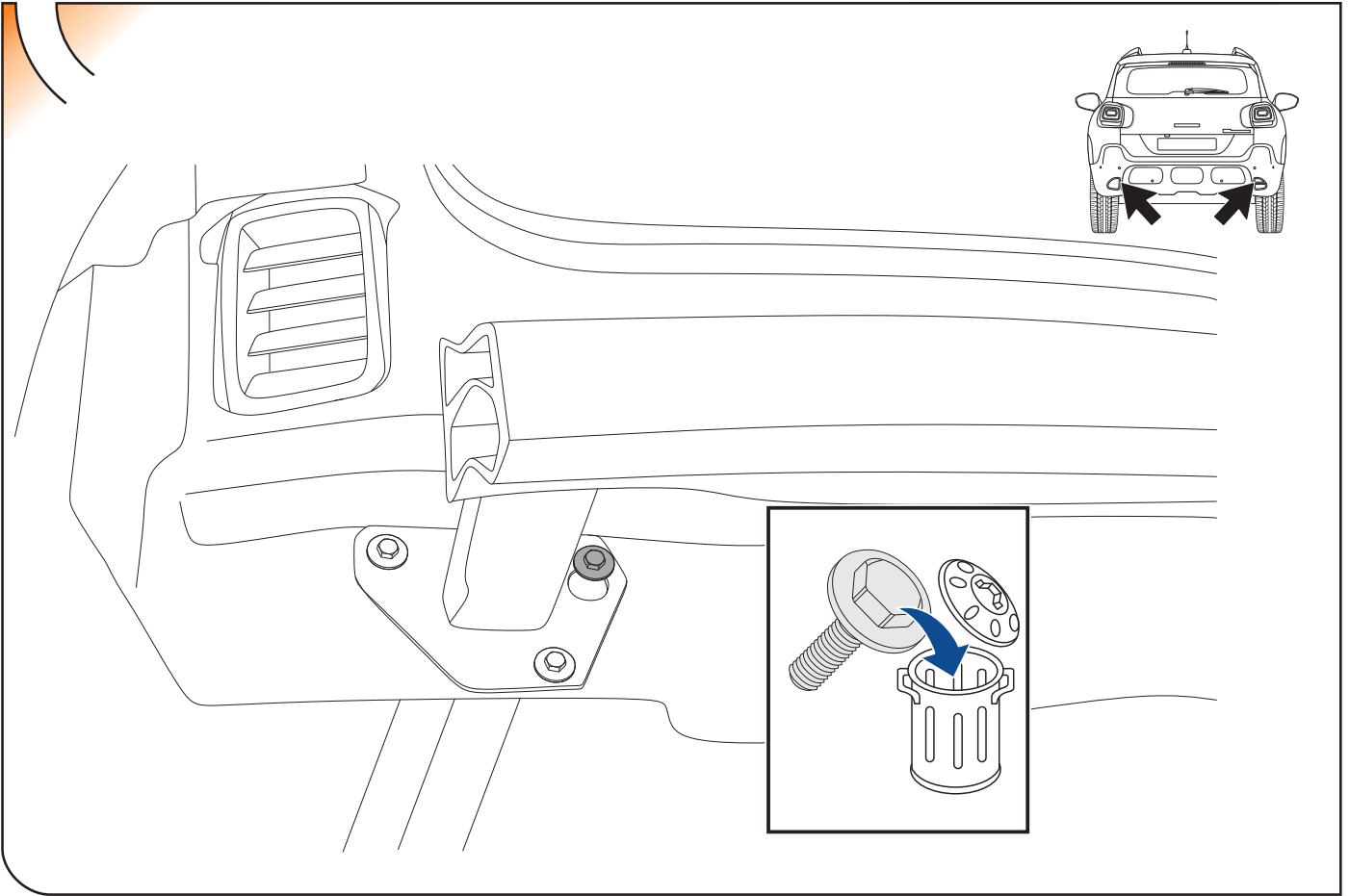

6

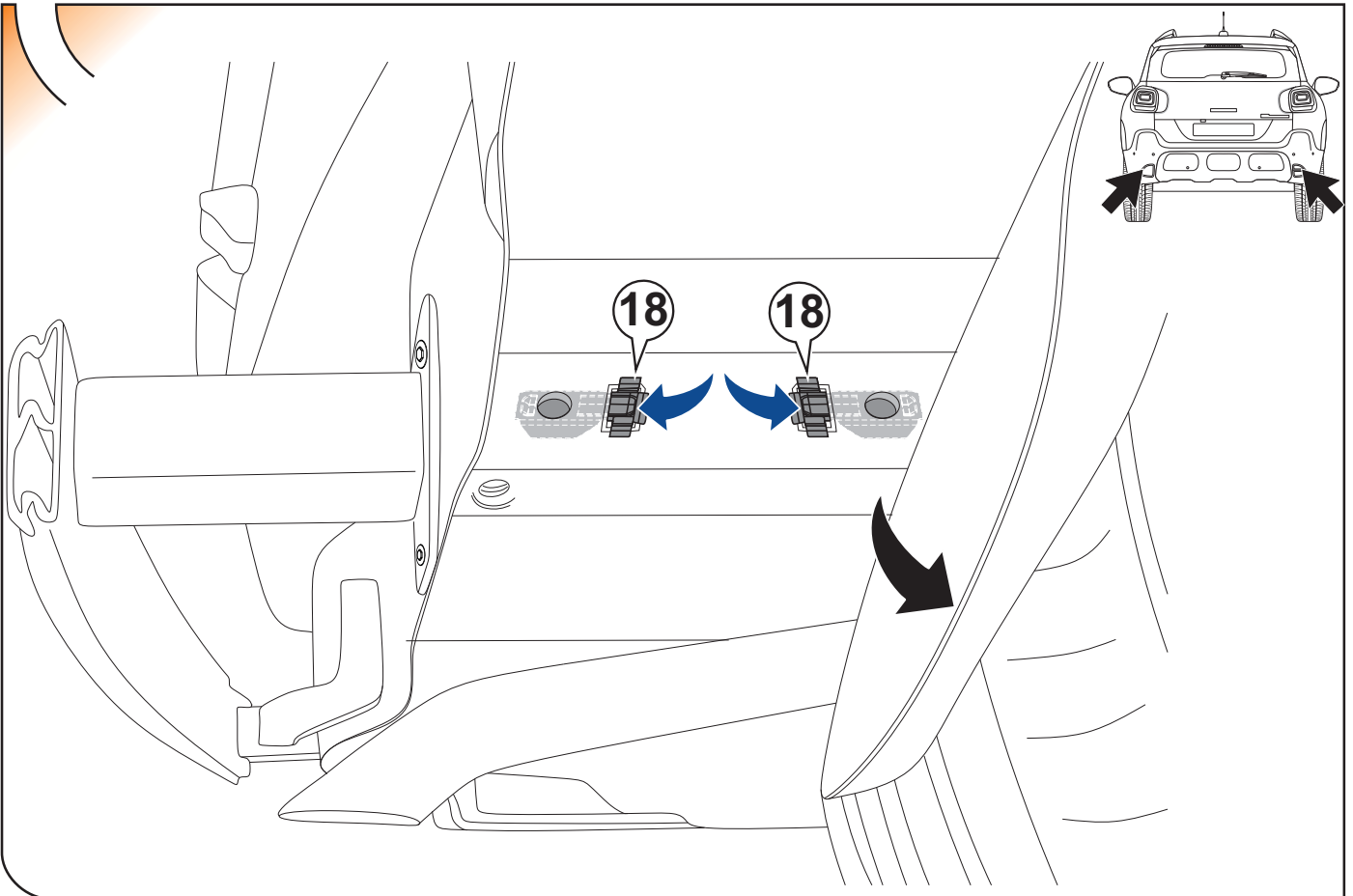

7

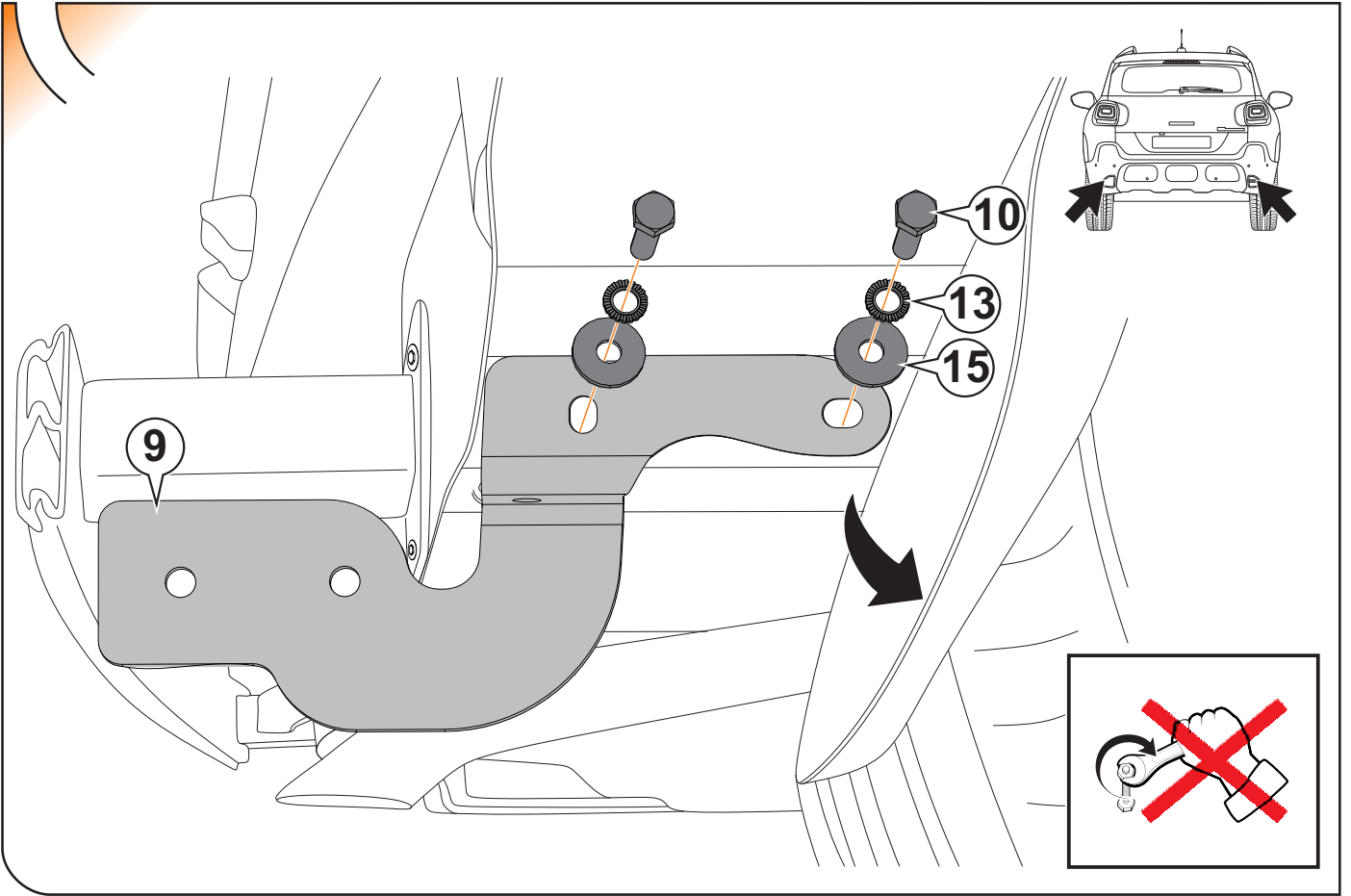

8

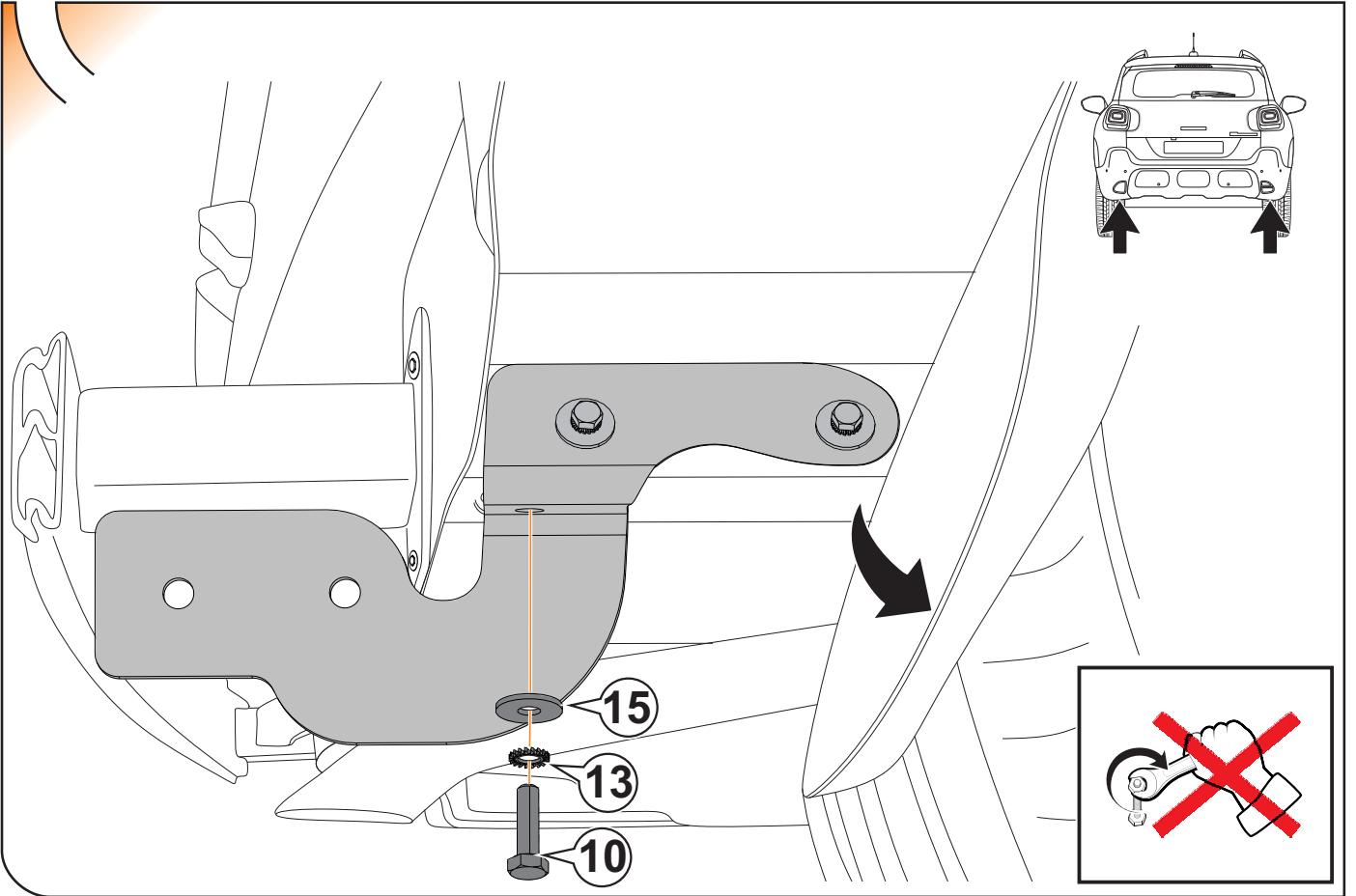

9

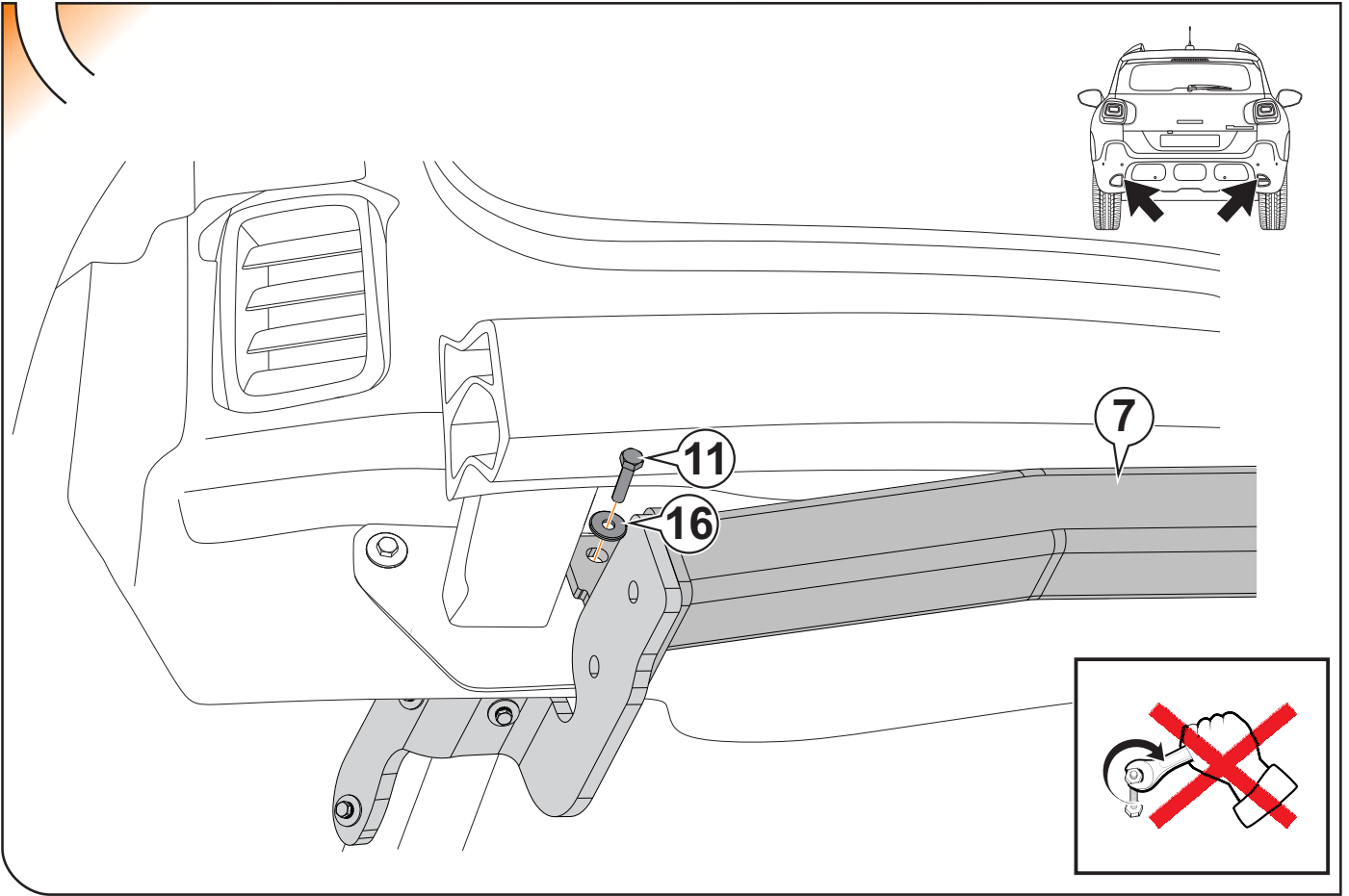

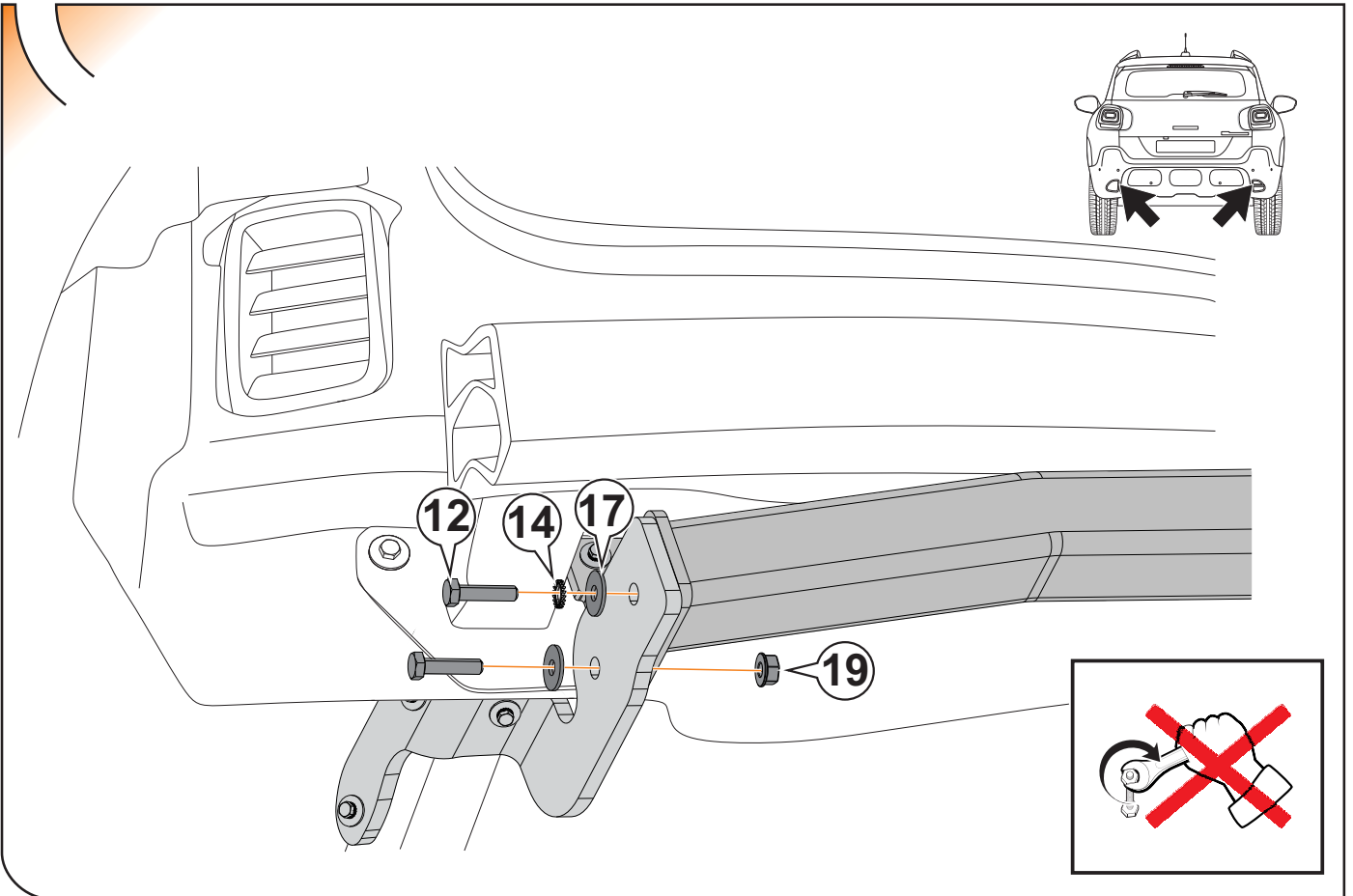

10

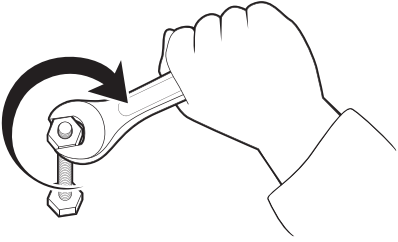

11



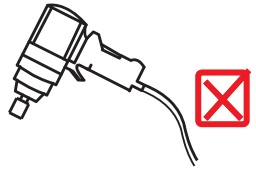

	M8	M10	M12	M14	M16
N/m	20	40	60	105	160

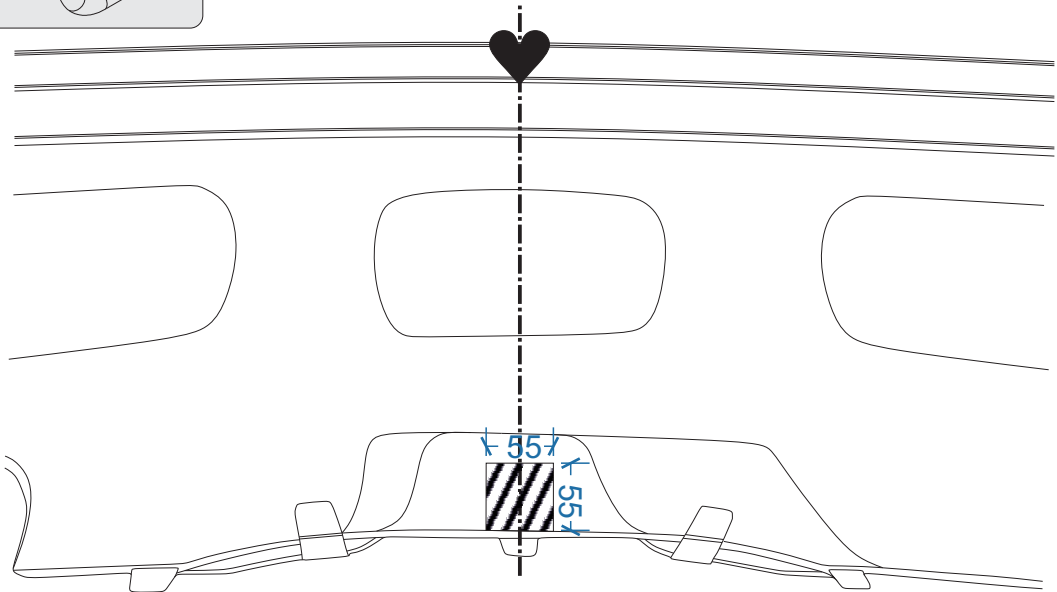
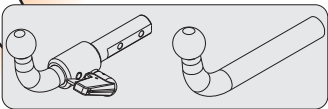

Nm

12

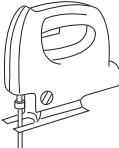
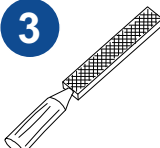

- 
- 
- 

13

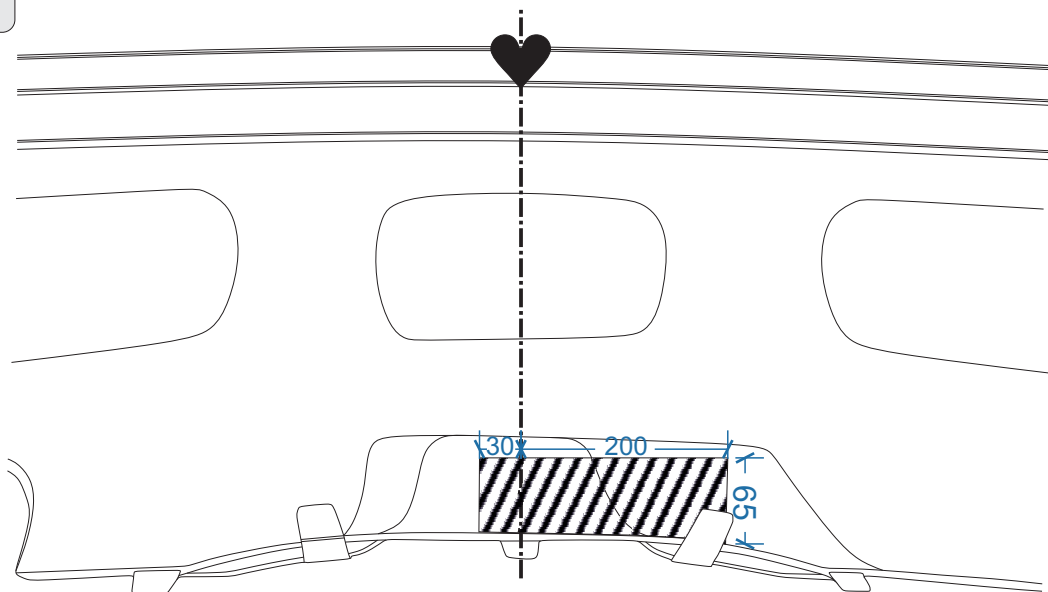
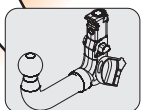

1



2

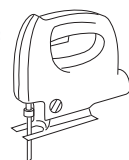

3

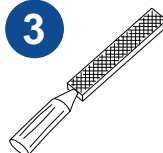

14

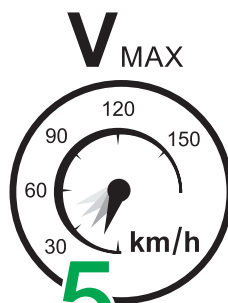

5

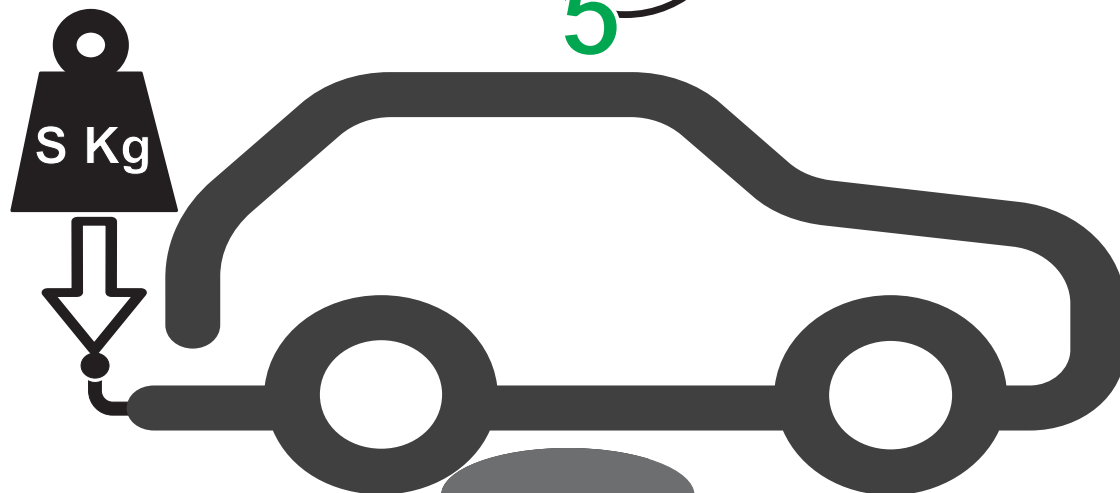

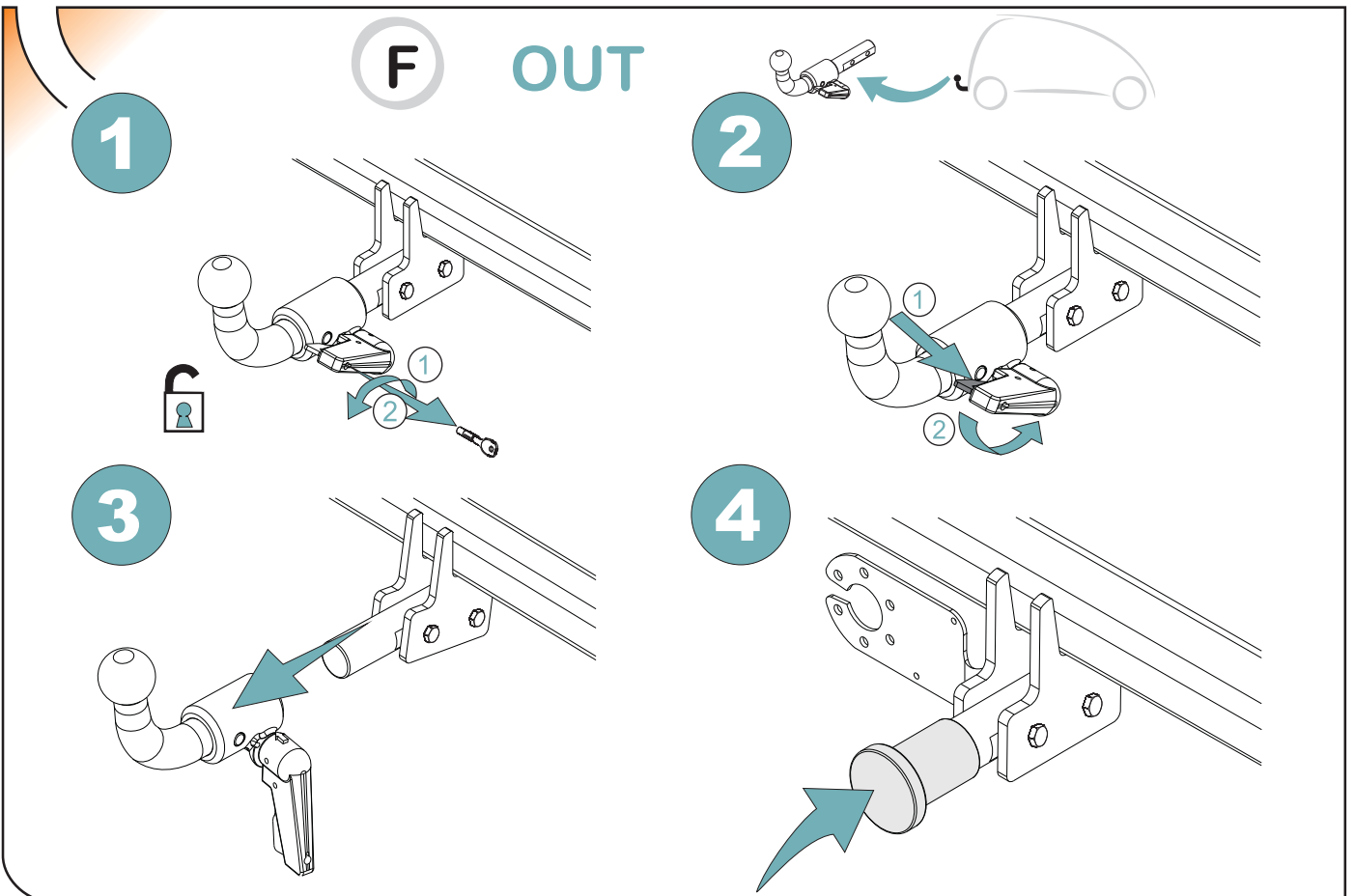
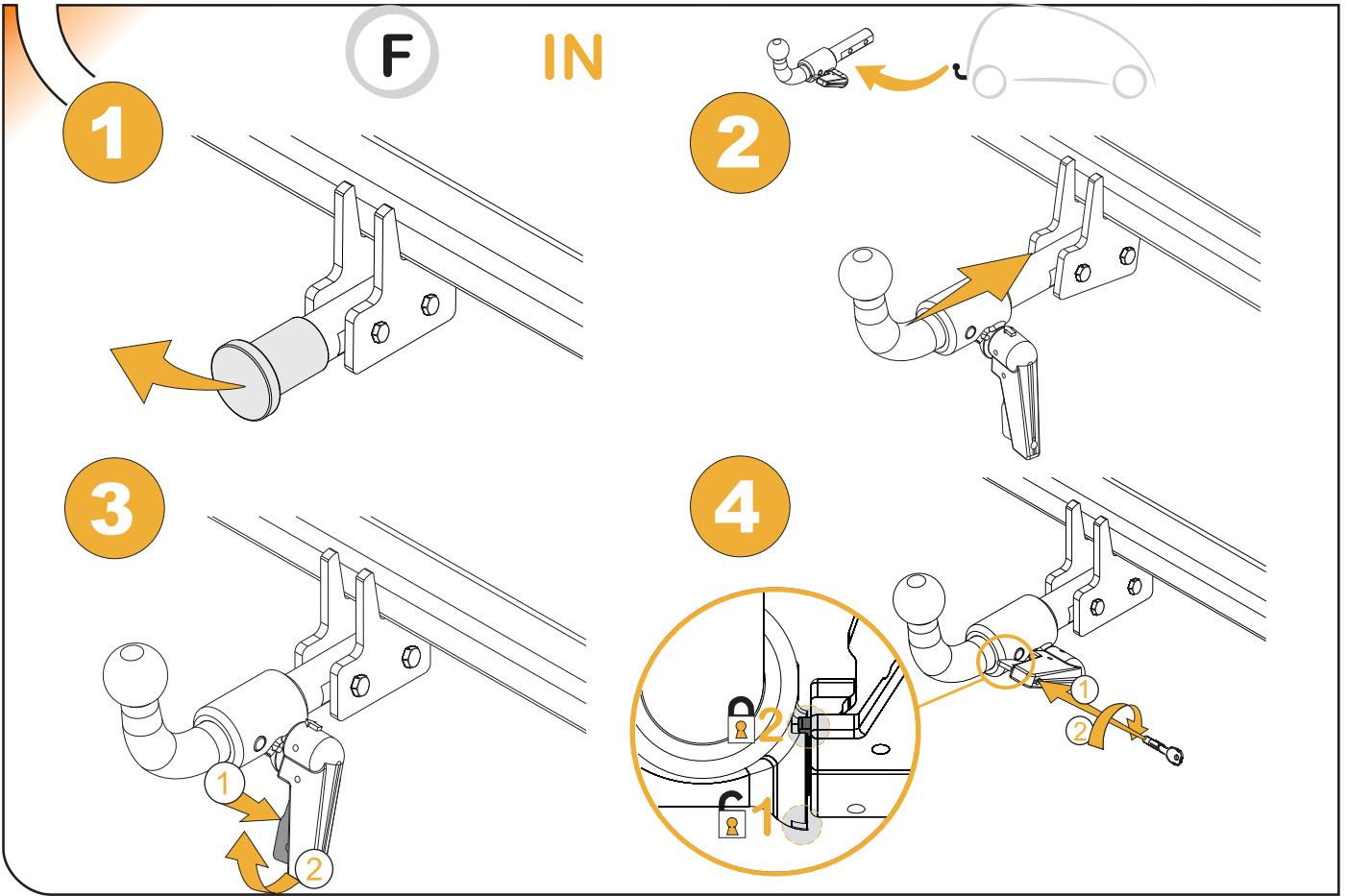

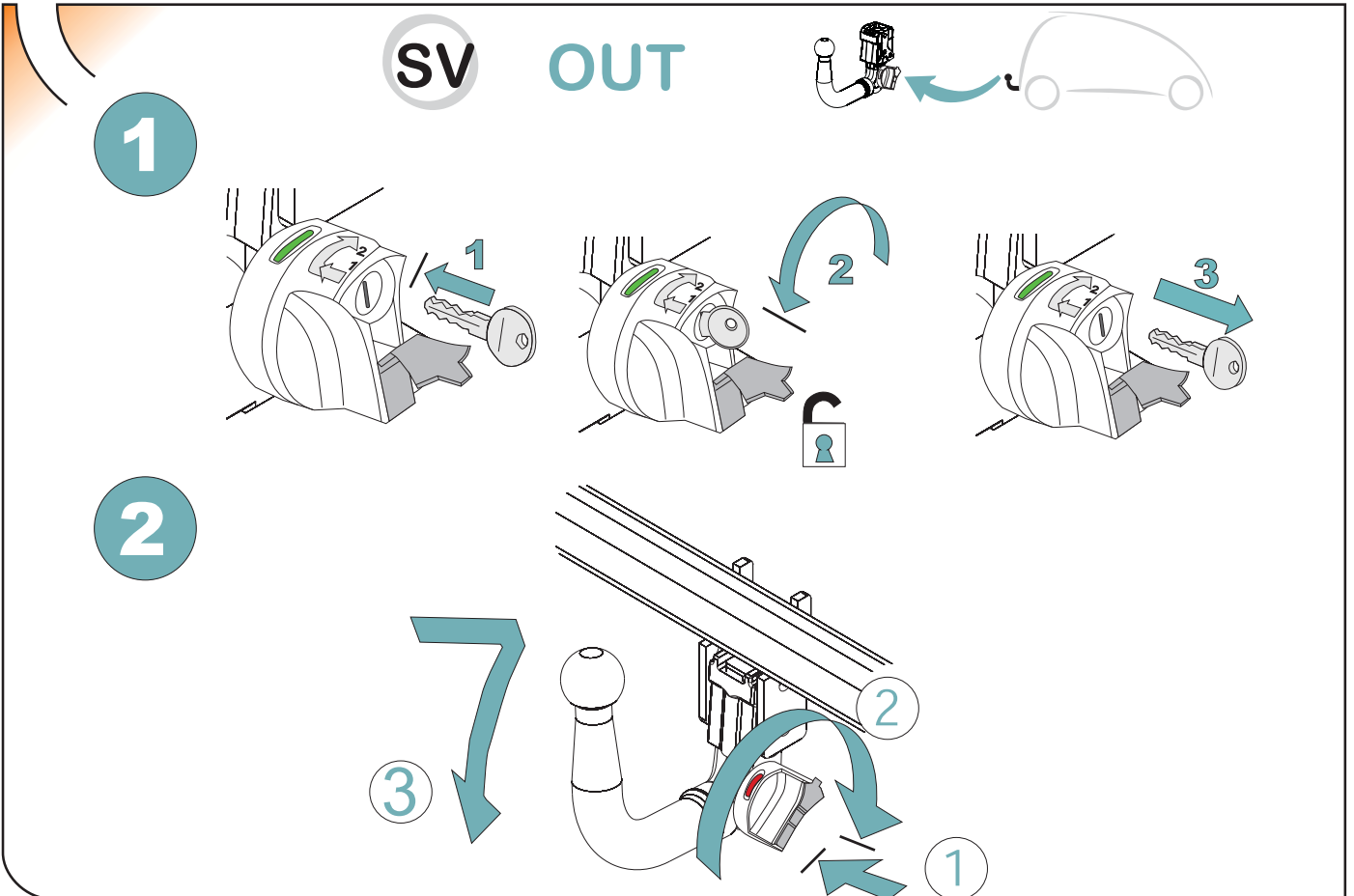
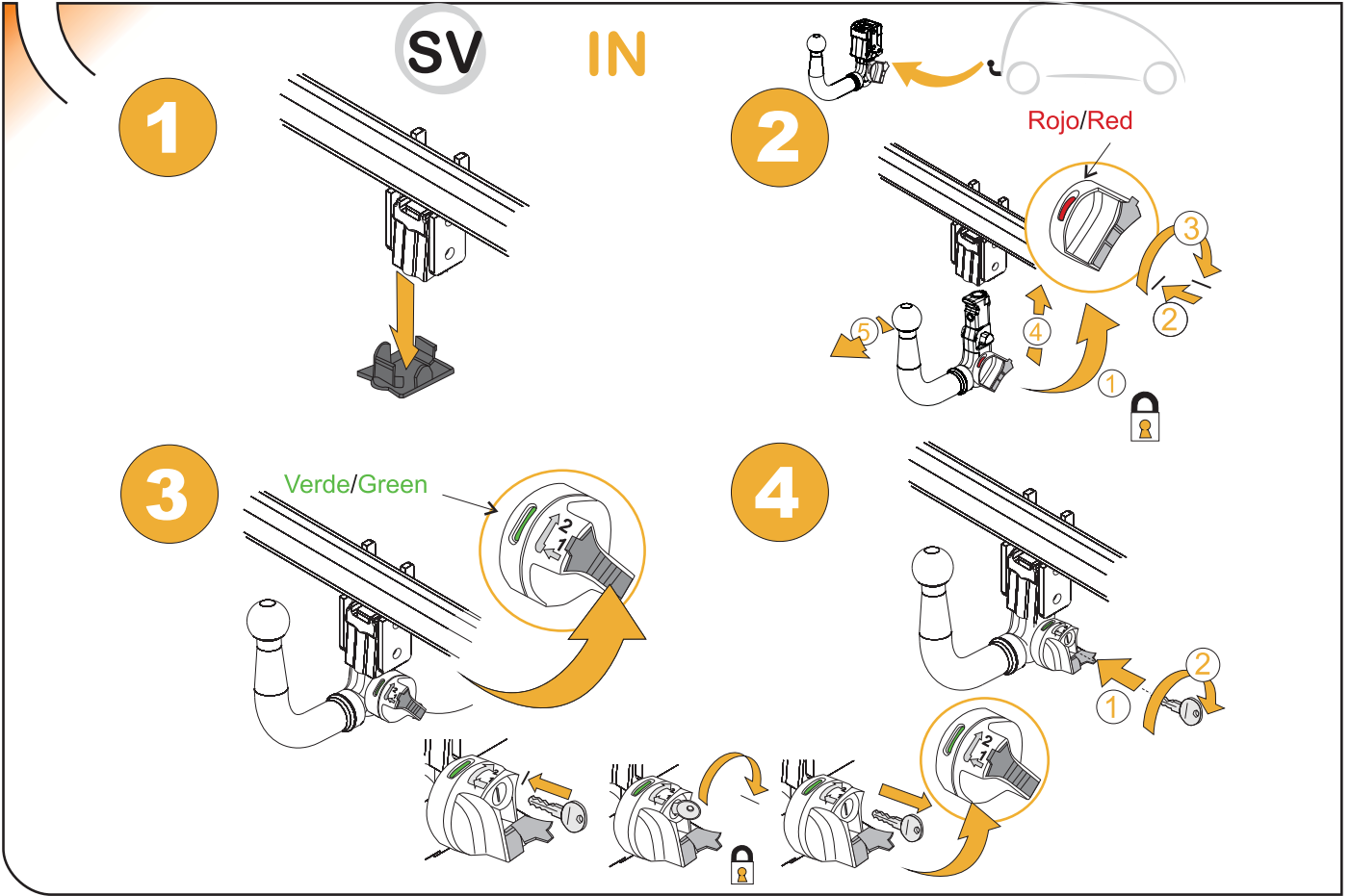

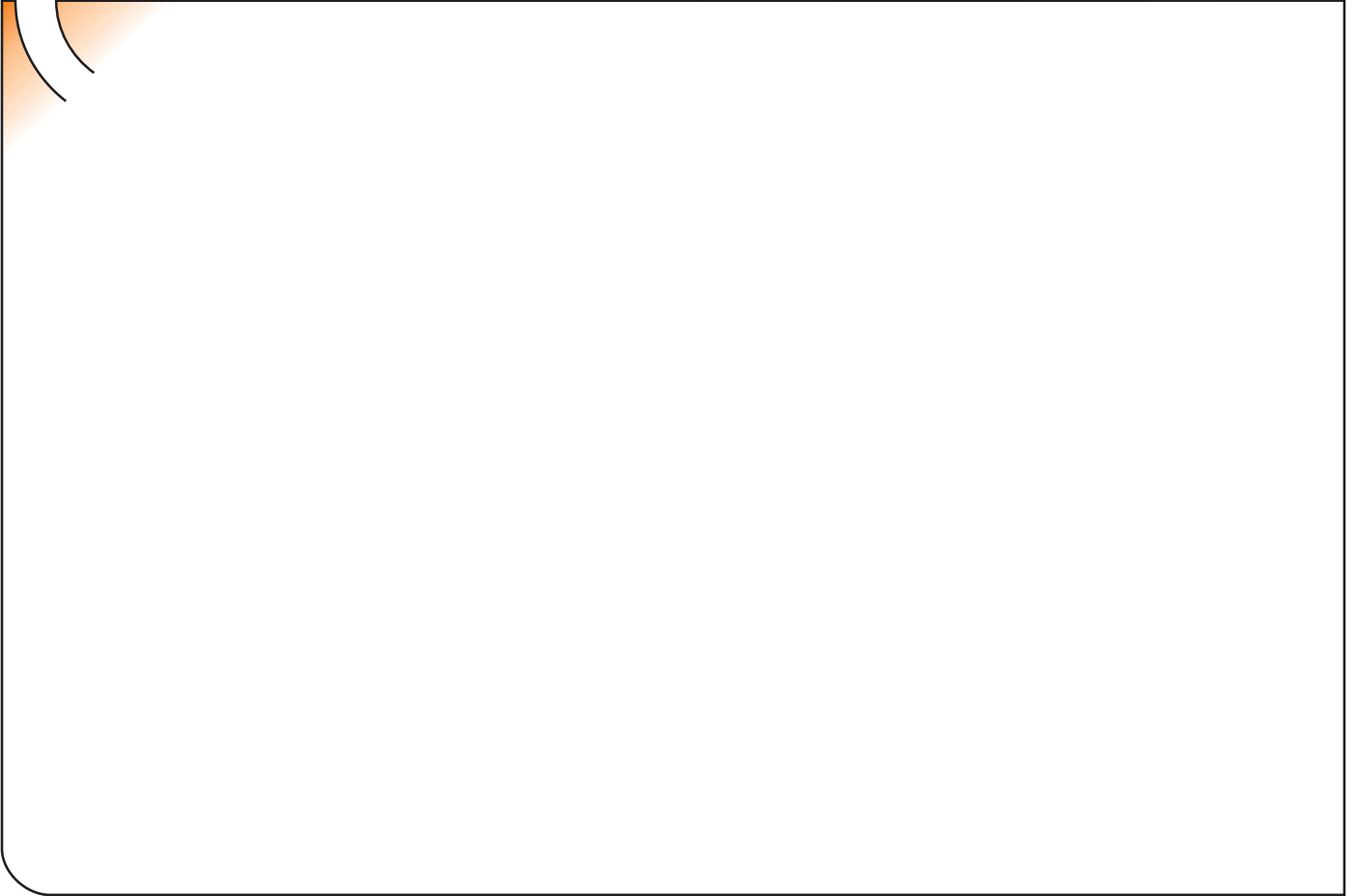

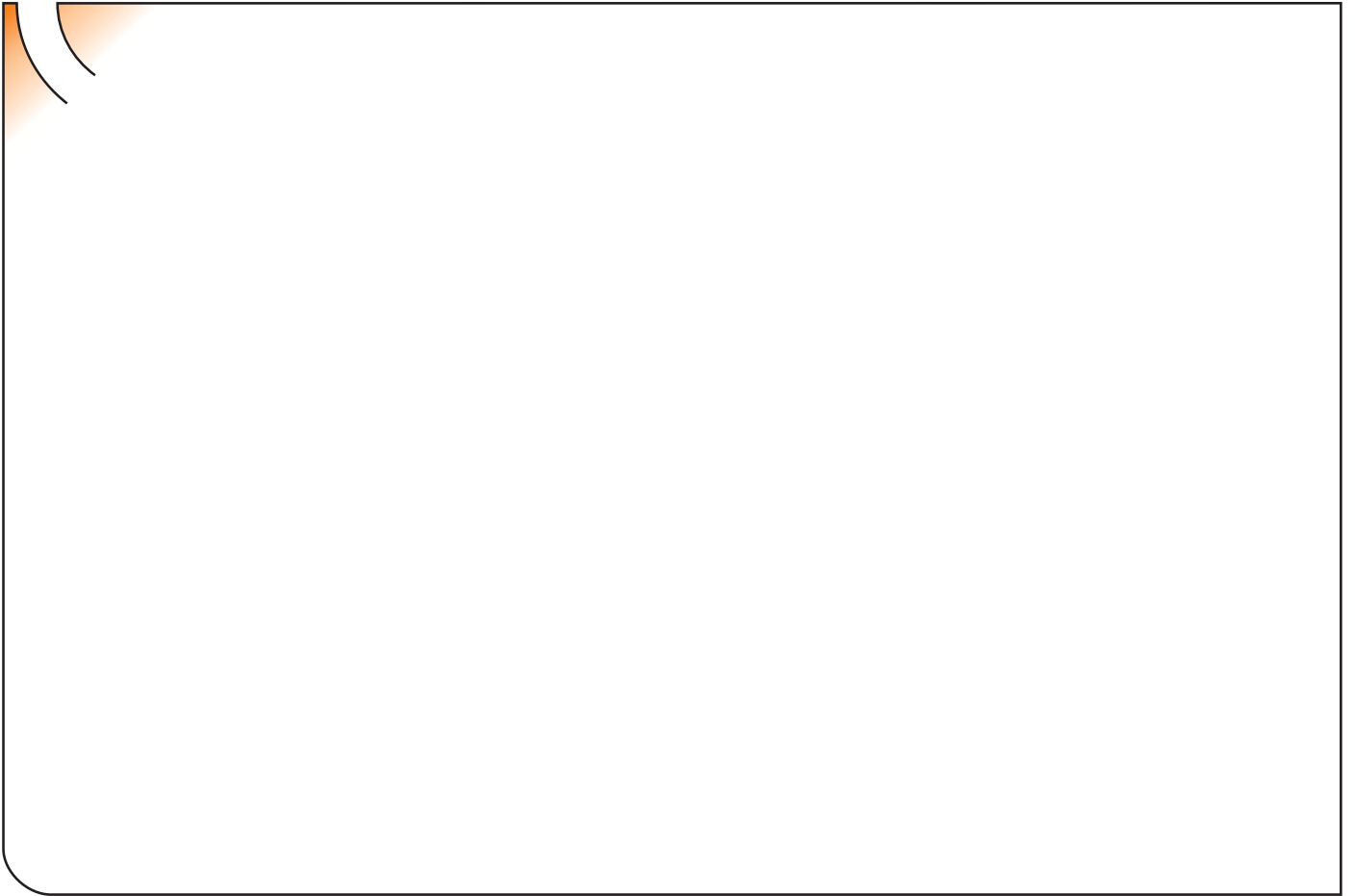

ANEXO III

CERTIFICADO DE TALLER

D. _____, expresamente autorizado por la _____
domiciliada en _____, teléfono _____, dedicada
a la actividad de _____ n° de Registro Industrial _____ y n° de registro
especial _____.

CERTIFICA

Que la mencionada empresa ha realizado la/s Reforma/s y asume la responsabilidad de la ejecución,
sobre el vehículo marca....., tipo.....
variante..... denominación comercial
matrícula y n° de bastidor, de acuerdo con:

- La normativa vigente en materia de reformas de vehículos.
- Las normas del fabricante del vehículo aplicables a la/s reforma/s llevadas a cabo en dicho vehículo.
- El proyecto descriptivo de la/s reforma/s, adjunto al expediente.

OBSERVACIONES: (2)

Tipificada/s con el código de reforma/s.....
Reforma consiste en:

COLOCACION DE ENGANCHE _____

n° de identificación / marca de homologación

Type :

Fecha:

Firma y sello:

Fdo:

(1) En el caso de que la reforma sea efectuada por el fabricante se indicará N/A.

(2) Se debe especificar en este apartado OBSERVACIONES, la identificación de los equipos o sistemas modificados, garantizando que se cumple lo previsto en el artículo 6 del reglamento general de vehículos y, en su caso, en el artículo 5 del R. D. 1457/1986 de 10 de enero, por el que se regula la actividad industrial en talleres de vehículos automóviles, de equipos y sus componentes, modificado por 455/2010 de 16 de abril, por el que se modifica el R. D. 1457/1986 de 10 de enero por el que se regulan la actividad industrial y la prestación.

ES

1



2

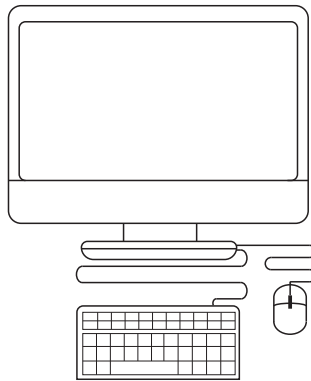

3



IT

1

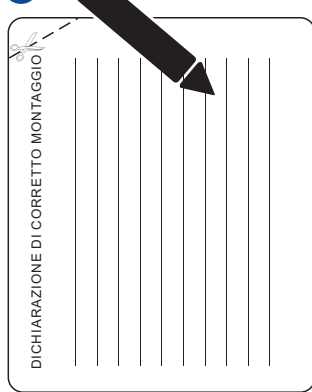

2

